

SIGN PUNCHING, STRINGER AND SUPPORT LOCATION  
DETAILS REGULATORY, WARNING AND GUIDE SIGNS

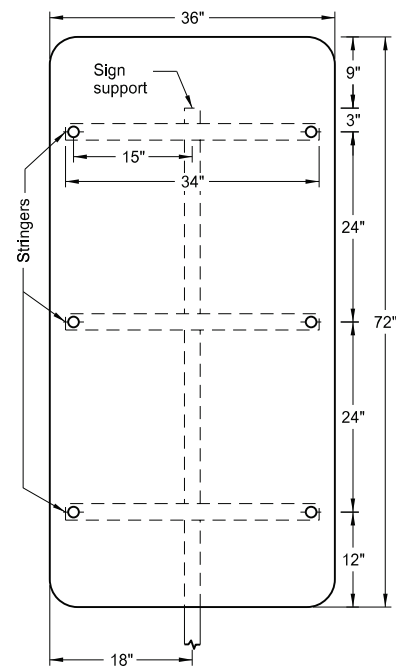

1 Post

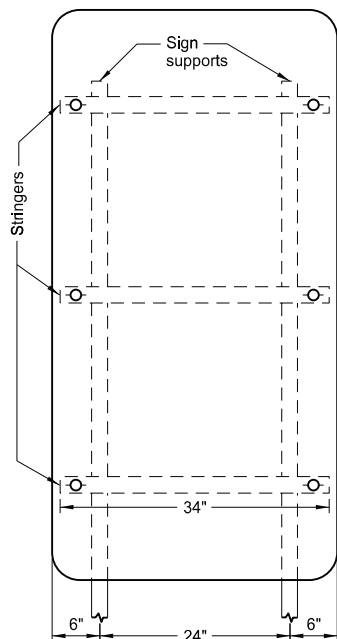

2 Posts

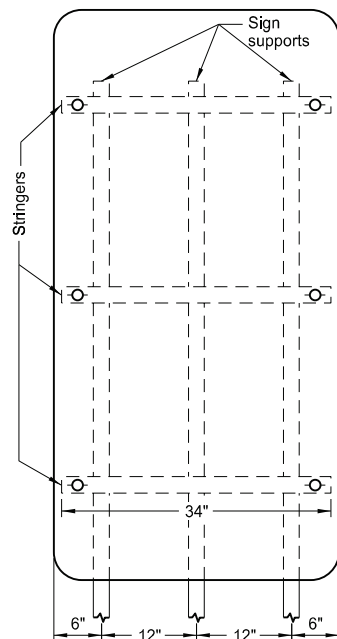

3 Posts

Assembly No. 24

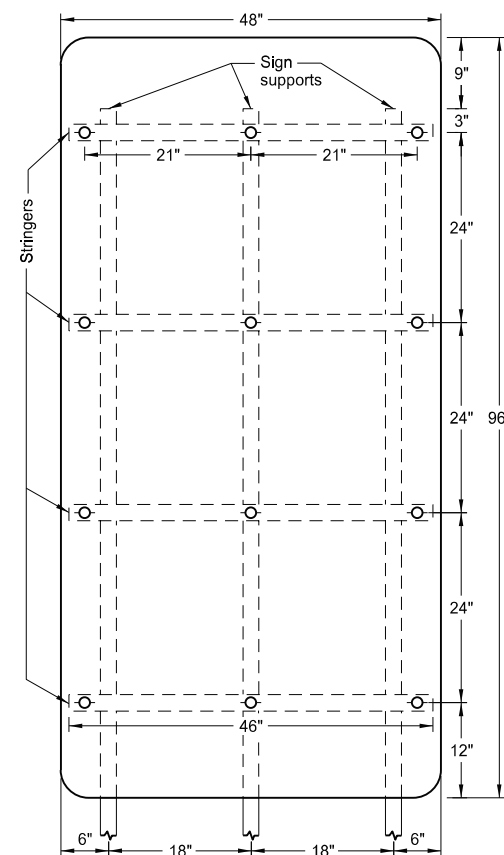

3 Posts

Assembly No. 25

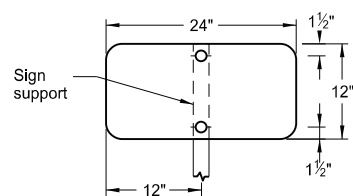

1 Post

Assembly No. 26

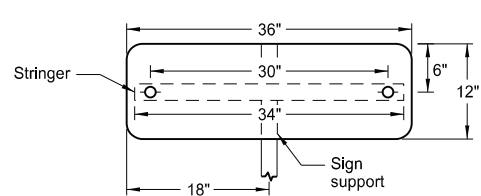

1 Post

Assembly No. 27

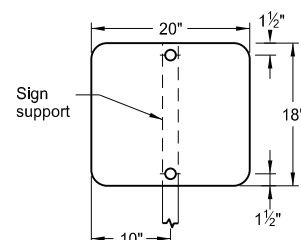

1 Post

Assembly No. 28

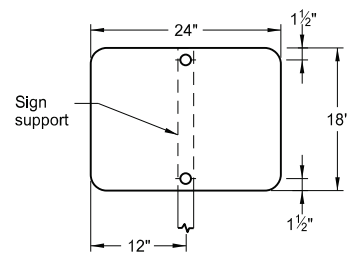

1 Post

Assembly No. 29

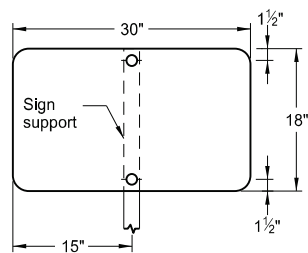

1 Post

Assembly No. 30

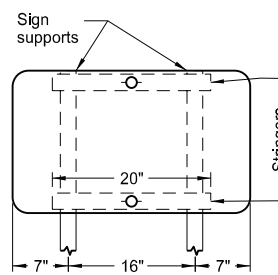

2 Posts

Notes:

1. Use 0.100 inch minimum thickness sign backing material.
2. Use 1 1/2" x 1 1/2" perforated square tube stringers.
3. Punch holes round for 3/8" bolt.

NORTH DAKOTA DEPARTMENT OF TRANSPORTATION	
12-1-10	
REVISIONS	
DATE	CHANGE
8-30-18	Updated notes to active voice.
8-30-19	New Design Engineer PE Stamp.
8-06-24	Electronic Stamp/Signature.



08/06/24