

NDDOT ABBREVIATIONS

D-101-1

? This is a special text character used in the labeling of existing features. It indicates a feature that has an unknown characteristic, potentially based on: lack of description, location accuracy or purpose.

Abn abandoned
 Abut abutment
 Adj adjusted
 Aggr aggregate
 Ahd ahead
 ARV air release valve
 Align alignment
 Al alley
 Alt alternate
 Alum aluminum
 ADA Americans with Disabilities Act
 & and
 Appr approach
 Approx approximate
 ACP asbestos cement pipe
 Asph asphalt
 AC asphalt cement
 Assmd assumed
 @ at
 Atten attenuation
 ATR automatic traffic recorder
 Ave Avenue
 Avg average
 ADT average daily traffic

Bk back
 BF back face
 Balc balcony
 B Wire barbed wire
 Barr barricade
 Btry battery
 BI beehive inlet
 Beg begin
 BG below grade
 BM bench mark
 Bkwy bikeway
 Bit bituminous
 Blk block
 BH bore hole
 Bot bottom
 Blvd Boulevard
 Bndry boundary
 Brkwy breakaway
 Br bridge
 Bldg building
 Bus. business
 BV butterfly valve
 Byp bypass

C Gdrl cable guardrail
 Calc calculate
 CIP cast iron pipe
 CB catch basin
 CRS cationic rapid setting
 C Gd cattle guard
 C To C center to center
 CL or C centerline
 Ch chain
 Chnlk chain-link
 Ch Blk channel block
 Ch Ch channel change
 Chk check
 Chsld chiseled
 Cir circle
 Cl class
 Clnt clean-out
 Clr clear
 Cl&gr clearing & grubbing
 Comb. combination
 Coml commercial
 Compr compression
 CADD computer aided drafting & design
 Conc concrete
 CECB concrete erosion control blanket
 Cond conductor
 Const construction
 Cont continuous
 CSB continuous split barrel sample
 Contr contraction
 Contr contractor
 CP control point
 Coord coordinate
 Cor corner
 Corr corrected
 CAES corrugated aluminum end section
 CAP corrugated aluminum pipe
 CMES corrugated metal end section
 CMP corrugated metal pipe
 CPVCP corrugated poly-vinyl chloride pipe
 CSES corrugated steel end section
 CSFES corrugated steel flared end section
 CSP corrugated steel pipe
 CSTES corrugated steel traversable end section
 Co County
 Crse course
 Ct Court
 Xarm cross arm
 Xbuck cross buck
 Xsec cross sections
 Xing crossing
 Xrd crossroad
 Crn crown

Culv culvert
 C&G curb & gutter
 CI curb inlet
 CR curb ramp
 C cut
 Dd Ld dead load
 Defl deflection
 Defm deformed
 DInt delineate
 DIntr delineator
 Depr depression
 Desc description
 Det detail
 DWP detectable warning panel
 Dtr detour
 Dia or \emptyset diameter
 Dir direction
 Dist distance
 DM disturbed material
 DB ditch block
 DG ditch grade
 Dbl double
 Dn down
 Dwg drawing
 Dr drive
 Drwy driveway
 DI drop inlet
 D dry density

Ea each
 Esmt easement
 E East
 EB Eastbound
 Elast elastomeric
 EL electric locker
 E Mtr electric meter
 Elec electric/al
 EDM electronic distance meter
 Elev or El elevation
 Ellipt elliptical
 Emb embankment
 Emuls emulsion/emulsified
 ES end section
 Engr engineer
 ESS environmental sensor station
 Eq equal
 Evgr evergreen
 Exc excavation
 Exst existing
 Exp expansion
 Expy Expressway
 E external of curve
 Extru extruded

FOS factor of safety
 Fed Federal
 FP feed point
 Fn fence
 Fn P fence post
 FO fiber optic
 FD field drive
 F fill
 FAA fine aggregate angularity
 FH fire hydrant
 Fl flange
 Flrd flared
 FES flared end section
 F Bcn flashing beacon
 FA flight auger sample
 FL flow line
 Ftg footing
 FM force main
 Fnd found
 Fdn foundation
 Frac fractional
 Frwy freeway
 Frt front
 FF front face
 F Disp fuel dispenser
 FFP fuel filler pipes
 FLS fuel leak sensor
 Furn furnish/ed

NORTH DAKOTA DEPARTMENT OF TRANSPORTATION	
07-01-14	
REVISIONS	
DATE	CHANGE
04-23-18	General Revisions
05-20-18	General Revisions
12-10-20	General Revisions
08-16-22	General Revisions



NDDOT ABBREVIATIONS

Galv	galvanized	Ln	lane	Obsc	obscure(d)	Qty	quantity
Gar	garage	Lg	large	Ocpd	occupied	Qtr	quarter
Gs L	gas line	Lat	latitude	Ocpy	occupy		
G Reg	gas line regulator	Lt	left	O/s	offset		
GMV	gas main valve	Lens	lenses	OC	on center	Rad or R	radius
G Mtr	gas meter	Lvl	level	C	one dimensional consolidation	RR	railroad
GSV	gas service valve	Lvng	leveling	OC	organic content	Rlwy	railway
GVP	gas vent pipe	Lht	light	Orig	original	Rsd	raised
GV	gate valve	LP	light pole	O To O	out to out	RC	rapid curing
Ga	gauge	Ltg	lighting	OD	outside diameter	Rec	record
Gov	government	Liq	liquid	OH	overhead	Recy	recycle
Grd	graded/grade	LL	liquid limit			RAP	recycled asphalt pavement
Grnd	ground	Loc	location			RPCC	recycled portland cement concrete
GWM	ground water monitor	Long.	longitude	PMT	pad mounted transformer	Ref	reference
Gdrl	guardrail	Lp	loop	Pg	pages	R Mkr	reference marker
Gtr	gutter	LD	loop detector	Pntd	painted	RM	reference monument
		Lum	luminaire	Pr	pair	RP	reference point
				Pnl	panel	Refl	reflectorized
H Plg	H piling			Pk	park	RCB	reinforced concrete box
Hdwl	headwall	Mb	mailbox	PSD	passing sight distance	RCES	reinforced concrete end section
Ht	height	ML	main line	Pvmt	pavement	RCFES	reinforced concrete flared end section
Hel	helical	MH	manhole	Ped	pedestal	RCP	reinforced concrete pipe
HDPE	high density polyethylene	Mkd	marked	Ped	pedestrian	RCPS	reinforced concrete pipe sewer
HM	high mast	Mkr	marker	PPP	pedestrian pushbutton post	RCTES	reinforced concrete traversable end section
HP	high pressure	Mkg	marking	Pen.	penetration	Reinf	reinforcement
HPS	high pressure sodium	MA	mast arm	Perf	perforated	Res	reservation
HTCG	high tension cable guardrail	Matl	material	Per.	perimeter	Res	residence
Hwy	highway	Max	maximum	Perm	permanent	Ret	retaining
Hor	horizontal	MC	meander corner	PL	pipeline	Rev	reverse
HBP	hot bituminous pavement	Meas	measure	Pl	place	Rt	right
HMA	hot mix asphalt	Mdn	median	P&P	plan & profile	R/W	right of way
Hyd	hydrant	MD	median drain	PL	plastic limit	Riv	river
Ph	hydrogen ion content	MC	medium curing	Pl or \bar{P}	plate	Rd	road
		MGS	Midwest Guardrail System	Pt	point	Rdbd	road bed
		MM	mile marker	PE	polyethylene	Rdwy	roadway
Id	identification	MP	mile post	PVC	polyvinyl chloride	RWIS	roadway weather information system
Incl	inclinometer tube	Min	minimum	PCC	Portland Cement concrete	Rk	rock
IMH	inlet manhole	Misc	miscellaneous	PP	power pole	Rt	route
ID	inside diameter	Mon	monument	Preempt	preemption		
Inst	instrument	Mnd	mound	Prefab	prefabricated		
Intchg	interchange	Mtbl	mountable	Prfmd or Pref	performed		
Intmdt	intermediate	Mtd	mounted	Prep	preparation		
Intscn	intersection	Mtg	mounting	Press.	pressure		
Inv	invert	Mk	muck	PRV	pressure relief valve		
IP	iron pipe			Prestr	prestressed		
				Pvt	private		
				PD	private drive		
Jt	joint	Neop	neoprene	Prod.	production/produce		
Jct	junction	Ntwk	network	Prog	programmed		
		N	North	Prop.	property		
		NE	North East	Prop Ln	property line		
		NW	North West	Ppsd	proposed		
		NB	Northbound	PB	pull box		
		No. or #	number				

NORTH DAKOTA DEPARTMENT OF TRANSPORTATION	
07-01-14	
REVISIONS	
DATE	CHANGE
08-03-15	General Revisions
04-23-18	General Revisions
12-18-20	General Revisions
08-16-22	General Revisions

08/16/22

NDDOT ABBREVIATIONS

D-101-3

Salv	salvage(d)	Tel	telephone
San	sanitary sewer line	Tel B	Telephone Booth
Sec	section	Tel P	telephone pole
SL	section line	Tv	television
Sep	separation	Temp	temperature
Seq	sequence	Temp	temporary
Serv	service	TBM	temporary bench mark
Sht	sheet	T	thinwall tube sample
Shtng	sheeting	Ts	topsoil
Shldr	shoulder	Traf	traffic
Sw or Sdwk	sidewalk	TSCB	traffic signal control box
SD	sight distance	Tr	trail
SN	sign number	Transf	transformer
Sig	signal	Trans	transition
Sgl	single	TT	transmission tower
SRCP	slotted reinforced concrete pipe	TES	traversable end section
SC	slow curing	Trans	transverse
SS	slow setting	Trtd	treated
Sm	small	Trmt	treatment
S	South	Qc	triaxial compression
SE	South East	TERO	tribal employment rights ordinance
SW	South West	Tpl	triple
SB	Southbound	Typ	typical
Sp	spaces		
Spcl	special	Qu	unconfined compressive strength
SA	special assembly	Ugrnd	underground
SP	special provisions	Util	utility
G	specific gravity		
Spk	spike	VG	valley gutter
SB	split barrel sample	Vap	vapor
SH	sprinkler head	Vert	vertical
SV	sprinkler valve	VCP	vitrified clay pipe
Sq	square	Vol	volume
Stk	stake	VSFS	vehicle speed feedback sign
Std	standard		
N	standard penetration test	Wkwy	walkway
Std Specs	standard specifications	W	water content
Stm L	steam line	WGV	water gate valve
SEC	steel encased concrete	WL	water line
SMA	stone matrix asphalt	WM	water main
SSD	stopping sight distance	WMV	water main valve
SD	storm drain	W Mtr	water meter
St	street	WSV	water service valve
SPP	structural plate pipe	WW	water well
SPPA	structural plate pipe arch	Wrng	wearing
Str	structure	WIM	weigh in motion
Subd	subdivision	W	west
Sub	subgrade	WB	westbound
Sub Prep	subgrade preparation	Wrng	wiring
Ss	subsoil	W/	with
SS	supplement specification	W/o	without
Supp	supplemental	WC	witness corner
Surf	surfacing		
Surv	survey		
Sym	symmetrical		

NORTH DAKOTA DEPARTMENT OF TRANSPORTATION	
07-01-14	
REVISIONS	
DATE	CHANGE
08-03-15	General Revisions
04-23-18	General Revisions
12-18-20	General Revisions
08-16-22	General Revisions



08/16/22

MEASUREMENTS

ac acres
 A ampere
 Bd Ft board feet
 Cd candela
 cm centimeter
 C coulomb
 CF cubic feet
 m3 cubic meter
 m3/s cubic meters per second
 CY cubic yard
 CY/mi cubic yards per mile
 D or Deg degree
 F Fahrenheit
 F farad
 ft feet/foot
 Gal gallon
 G giga
 Ha hectare
 H henry
 Hz hertz
 hr hour(s)
 in inch
 J joule
 K kelvin
 kN kilo newton
 kPa kilo pascal
 kg kilogram
 kg/m3 kilogram per cubic meter
 km kilometer
 K Kip(s)
 LF linear foot
 L litre
 Lm lumen
 L sum lump sum
 Lx lux
 M Hr man hour
 M mega
 m meter
 m/s meters per second
 mi mile
 mL milliliter
 mm millimeter
 mm/hr millimeters per hour
 n nano
 N newton
 Pa pascal
 lb pounds
 sec seconds
 S siemens
 SF square feet
 km2 square kilometer
 m2 square meter
 SY square yard
 Sta Yd station yards
 SI Systems International

T tesla
 T/mi tons per mile
 V volt
 W watt
 Wb weber

SURVEY DESCRIPTIONS

Az azimuth
 Bs backsight
 Brg bearing
 BP Cap blue plastic cap
 BS both sides
 BC brass cap
 CS curve to spiral
 Eq equation
 E external of curve
 FS far side
 FB field book
 Fs foresight
 Geod geodetic
 GIS Geographical Information System
 GPS Global Positioning System
 HI height of instrument
 IM iron monument
 I Pn iron pin
 LS Land Surveyor (licensed)
 LSIT Land Surveyor In Training
 L length of curve
 LC long chord
 LB level book
 Mer meridian
 M mid ordinate of curve
 NGS National Geodetic Survey
 NS near side
 Obsn observation
 Off Loc office location
 OP Cap orange plastic cap
 PK Parker-Kalon nail
 P Cap plastic cap
 PP Cap pink plastic cap
 PCC point of compound curve
 PC point of curve
 PI point of intersection
 PRC point of reverse curvature
 PT point of tangent
 POC point on curve
 POT point on tangent
 RTP random traverse point
 Rge range
 RP Cap red plastic cap
 SC spiral to curve
 ST spiral to tangent
 Sta station
 SE superelevation
 Tan tangent
 T tangent (semi)
 TS tangent to spiral
 Twp township
 TB transit book
 TP traverse point
 TP turning point
 USC&G US Coast & Geodetic Survey
 USGS US Geologic Survey
 VC vertical curve
 WGS World Geodetic System
 YP Cap yellow plastic cap
 Z zenith

SOIL TYPES

Cl clay
 Cl F clay fill
 Cl Hvy clay heavy
 Cl Lm clay loam
 Co S coal slack
 C Gr coarse gravel
 CS coarse sand
 FS fine sand
 Gr gravel
 Lig Co lignite coal
 Lig Sl lignite slack
 Lm loam
 Rk rock
 Sd sand
 Sdy Cl sandy clay
 Sdy Cl Lm sandy clay loam
 Sdy Fl sandy fill
 Sdy Lm sandy loam
 Sc scoria
 Sh shale
 Si Cl silt clay
 Si Cl Lm silty clay loam
 Si Lm silty loam

NORTH DAKOTA DEPARTMENT OF TRANSPORTATION	
07-01-14	
REVISIONS	
DATE	CHANGE
12-18-20	Sheet Added - Continued from D-101-3



NDDOT UTILITY COMPANY AND ORGANIZATION ABBREVIATIONS

D-101-10

702COM	702 Communications	GT PLNS NAT GAS	Great Plains Natural Gas Company	RED RIV COMM	Red River Rural Communications
ACCENT	Accent Communications	HALS TEL	Halstad Telephone Company	RESVTN TEL	Reservation Telephone
AGASSIZ WU	Agassiz Water Users Incorporated	IDEA1	Idea1	ROBRTS TEL	Roberts Company Telephone
AGC	Associated General Contractors of America	INT-COMM TEL	Inter-Community Telephone Company	R-RIDER ELEC	Roughrider Electric Cooperative
ALL PL	Alliance Pipeline	KANEB PL	Kaneb Pipeline Company	RRVW	Red River Valley & Western Railroad
ALL SEAS WU	All Seasons Water Users Association	KEM ELEC	Kem Electric Cooperative Incorporated	S CENT REG WD	South Central Regional Water District
AMOCO PI	Amoco Pipeline Company	KOCH GATH SYS	Koch Gathering Systems Incorporated	S E W U	South East Water Users Incorporated
AMRDA HESS	Amerada Hess Corporation	LKHD PL	Lakehead Pipeline Company	SCOTT CABLE	Scott Cable Television Dickinson
AT&T	AT&T Corporation	LNGDN RWU	Langdon Rural Water Users Incorporated	SHERDN ELEC	Sheridan Electric Cooperative
B PAW	Bear Paw Energy Incorporated	LWR YELL R ELEC	Lower Yellowstone Rural Electric	SHEYN VLY ELEC	Sheyenne Valley Electric Cooperative
BAKER ELEC	Baker Electric	MCKNZ CON	McKenzie Consolidated Telcom	SKYTECH	Skyland Technologies Incorporated
BASIN ELEC	Basin Electric Cooperative Incorporated	MCKNZ ELEC	McKenzie Electric Cooperative	SLOPE ELEC	Slope Electric Cooperative Incorporated
BEK TEL	Bek Communications Cooperative	MCKNZ WRD	McKenzie County Water Resource District	SOURIS RIV TELCOM	Souris River Telecommunications
BELLE PL	Belle Fourche Pipeline Company	MCLEOD	McLeod USA	ST WAT COMM	State Water Commission
BLM	Bureau of Land Management	MCLN ELEC	McLean Electric Cooperative	STATE LN WATER	State Line Water Cooperative
BNSF	Burlington Northern Santa Fe Railway	MCLN-SHRDN R WAT	McLean-Sheridan Rural Water	STER ENG	Sterling Energy
BOEING	Boeing	MDU	Montana-dakota Utilities	STUT RWU	Stutsman Rural Water Users
BRNS RWD	Barnes Rural Water District	MIDCO	MidContinent Communications	SW PL PRJ	Southwest Pipeline Project
BURK-DIV ELEC	Burke-Divide Electric Cooperative	MIDSTATE TEL	Midstate Telephone Company	T M C	Turtle Mountain Communications
BURL WU	Burleigh Water Users	MINOT CABLE	Minot Cable Television	TCI	TCI of North Dakota
CABLE ONE	Cable One	MINOT TEL	Minot Telephone Company	TESORO GHG PLNS PL	Tesoro High Plains Pipeline
CABLE SERV	Cable Services	MISS VALL COMM	Missouri Valley Communications	TRI-CNTY WU	Tri-County Water Users Incorporated
CAP ELEC	Capital Electric Cooperative Incorporat	MISS W W S	Missouri West Water System	TRL CO RWU	Traill County Rural Water Users
CASS CO ELEC	Cass County Electric Cooperative	MNKOTA PWR	Minnkota Power	UNTD TEL	United Telephone
CASS RWU	Cass Rural Water Users Incorporated	MOR-GRAN-SOU ELEC	Mor-gran-sou Electric Cooperative	UPPR SOUR WUA	Upper Souris Water Users Association
CAV ELEC	Cavalier Rural Electric Cooperative	MOUNT-WILLI ELEC	Mountrail-williams Electric Cooperative	US SPRINT	U.S. Sprint
CBLCOM	Cablecom Of Fargo	MRE LBTY TEL	Moore & Liberty Telephone	USAF MSL CABLE	U.S.A.F. Missile Cable
CENEX PL	Cenex Pipeline	MUNICIPAL	City Water And Sewer	USFWS	US Fish and Wildlife Service
CENT PL WATER DIST	Central Pipe Line Water District	MUNICIPAL	City Of '.....'	USW COMM	U.S. West Communications
CENT PWR ELEC	Central Power Electric Cooperative	N CENT ELEC	North Central Electric Cooperative	VRNDRY ELEC	Verendrye Electric Cooperative
CENTURYLINK	CenturyLink	N VALL W DIST	North Valley Water District	W RIV TEL	West River Telephone Incorporated
COE	Corps of Engineers	ND PKS & REC	North Dakota Parks And Recreation	WAPA	Western Area Power Administration
CONS TEL	Consolidated Telephone	ND TEL	North Dakota Telephone Company	WAWSA	Western Area Water Supply Authority
CONT RES	Continental Resource Inc	NDDOT	North Dakota Department of Transportation	WEB	W. E. B. Water Development Association
CPR	Canadian Pacific Railway	NDSU SOIL SCI DEPT	NDSU Soil Science Department	WILLI RWA	Williams Rural Water Association
D O E	Department Of Energy	NEMONT TEL	Nemont Telephone	WILSTN BAS PL	Williston Basin Interstate Pipeline Company
DAK CARR	Dakota Carrier Network	NODAK R ELEC	Nodak Rural Electric Cooperative	WLSH RWD	Walsh Water Rural Water District
DAK CENT TEL	Dakota Central Telephone	NOON FRMS TEL	Noonan Farmers Telephone Company	WOLVRTN TEL	Wolverton Telephone
DAK RWD	Dakota Rural Water District	NPR	Northern Plains Railroad	XLENER	Xcel Energy
DGC	Dakota Gasification Company	NSP	Northern States Power	YSVR	Yellowstone Valley Railroad
DICKEY R NET	Dickey Rural Networks	NTH PRAIR RW	Northern Prairie Rural Water Association		
DICKEY RWU	Dickey Rural Water Users Association	NTHN BRDR PL	Northern Border Pipeline		
DICKEY TEL	Dickey Telephone	NTHN PLNS ELEC	Northern Plains Electric Cooperative Incorporated		
DNRR	Dakota Northern Railroad	NTHWSTRN REF	Northwestern Refinery Company		
DOME PL	Dome Pipeline Company	NW COMM	Northwest Communication Cooperation		
DVELEC	Dakota Valley Electric Cooperative	NWRWD	Northwest Rural Water District		
DVMW	Dakota, Missouri Valley & Western	ONEOK	Oneok gas		
ENBRDG	Enbridge Pipelines Incorporated	OSHA	Occupational Safety and Health Administration		
ENVENTIS	Enventis Telephone	OTTR TL PWR	Otter Tail Power Company		
EQUINOR	Equinor Pipeline	PAAP	Plains All American Pipeline		
FALK MNG	Falkirk Mining Company	P L E M	Prairielands Energy Marketing		
FHWA	Federal Highway Administration	POLAR COM	Polar Communications		
G FKS-TRL WD	Grand Forks-traill Water District	PVT ELEC	Private Electric		
GETTY TRD & TRAN	Getty Trading & Transportation	QWEST	Qwest Communications		
GLDN W ELEC	Golden West Electric Cooperative	R&T W SUPPLY	R & T Water Supply Association		
GRGS CO TEL	Griggs County Telephone				
GTR RAMSEY WD	Greater Ramsey Water District				

NORTH DAKOTA DEPARTMENT OF TRANSPORTATION	
07-01-14	
REVISIONS	
DATE	CHANGE
04-23-18	General Revisions
05-20-18	General Revisions
12-18-20	General Revisions
08-16-22	General Revisions



LINE STYLES

D-101-20

Existing Topography

- Existing Ground Void
- Existing Cemetery Boundary
- Existing Box Culvert Bridge
- Existing Concrete Surface
- Existing Drainage Structure
- Existing Gravel Surface
- Existing Riprap
- Existing Dirt Surface
- Existing Asphalt Surface
- Existing Tie Point Line
- Existing Railroad Centerline
- Existing Guardrail Cable
- Existing Guardrail Metal
- Existing Edge of Water
- Existing Fence
- Existing Railroad
- Existing Field Line
- Exst Flow
- Existing Curb
- Existing Valley Gutter
- Existing Driveway Gutter
- Existing Curb and Gutter
- Existing Mountable Curb and Gutter

- Existing 3-Cable w Posts
- Site Boundary
- Existing Berm, Dike, Pit, or Earth Dam
- Existing Ditch Block
- Existing Tree Boundary
- Existing Brush or Shrub Boundary
- Existing Retaining Wall
- Existing Planter or Wall
- Existing W-Beam Guardrail with Posts
- Existing Railroad Switch
- Gravel Pit - Borrow Area
- Existing Wet Area-Vegetation Break
- Existing High Tension Cable Guardrail
- Existing High Tension Cable Guardrail with Posts

Proposed Topography

- 3-Cable w Posts
- Flow
- Fence
- Remove Line
- Wall
- Retaining Wall (Plan View)
- W-Beam w Posts
- High Tension Cable Guardrail with Posts

Existing Utilities

- Existing Electrical
- Existing Fiber Optic Line
- Existing TV Fiber Optic
- Existing Gas Pipe
- Existing Overhead Utility Line
- Existing Power
- Existing Fuel Pipeline
- Existing Undefined Above Ground Pipe Line
- Existing Sanitary Sewer
- Existing Sanitary Force Main
- Existing Storm Drain
- Existing Storm Drain Force Main
- Existing Culvert
- Existing Telephone Line
- Existing TV Line
- Existing Water or Steam Line
- Existing Under Drain
- Existing Slotted Drain
- Existing Conduit
- Existing Conductor
- Existing Down Guy Wire Down Guy
- Existing Underground Vault or Lift Station

Proposed Utilities

- 24 Inch Pipe
- Reinforced Concrete Pipe
- Under Drain
- Edge Drain

Traffic Utilities

- Conductor
- Fiber Optic
- Existing Loop Detector
- Existing Double Micro Loop Detector
- Micro Loop Detector Double
- Existing Micro Loop Detector
- Micro Loop Detector
- Signal Head with Mast Arm
- Existing Signal Head with Mast Arm

Sign Structures

- Existing Overhead Sign Structure
- Existing Overhead Sign Structure Cantilever
- Overhead Sign Structure Cantilever

NORTH DAKOTA DEPARTMENT OF TRANSPORTATION	
07-01-14 REVISIONS	
DATE	CHANGE
09-23-16	Added and Revised Items, Organized by Functional Groups General Revisions
12-18-20	

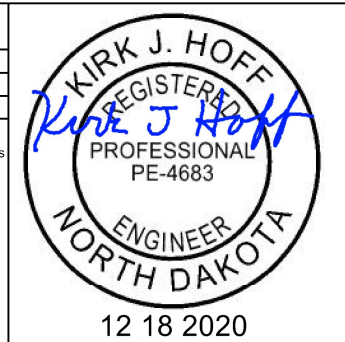

LINE STYLES

D-101-21

Right Of Way

- Easement
- Existing Easement
- Right of Way
- Existing Right of Way
- Existing Right of Way Railroad
- Existing Right of Way Not State Owned
- Existing Government Lot Line
- Existing Adjacent Block Lines
- Existing Adjacent Lot Lines
- Existing Adjacent Property Line
- Existing Adjacent Subdivision Lines
- Sight Distance Triangle Line
- Dimension Leader

Boundary Control

- ////// Existing City Corporate Limits or Reservation Boundary
- Existing State or International Line
- Existing Township
- Existing County
- Existing Section Line
- Existing Quarter Section Line
- Existing Sixteenth Section Line
- Existing Centerline
- Tangent Line

Cross Sections and Typical

- Existing Ground
- Existing Topsoil (Cross Section View)
- void - void - void - v Existing Ground Void (Not Surveyed)
- Existing Concrete
- Existing Aggregate (Cross Section View)
- Existing Curb and Gutter (Cross Section View)
- Existing Asphalt (Cross Section View)
- Existing Reinforcement Rebar

Geotechnical

- D ----- D ----- Geotextile Fabric Type D
- **Geo** ----- **Geo** ----- Geogrid
- R ----- R ----- Geotextile Fabric Type R
- R ----- R ----- Geotextile Fabric Type R1
- RR ----- RR ----- Geotextile Fabric Type RR
- S ----- S ----- Geotextile Fabric Type S

Countours

- Depression Contours
- Supplemental Contour

Profile

- Subgrade, Subcut or Ditch Grade
- Topsoil Profile

Striping

- Centerline Pavement Marking
- ===== Barrier with Centerline Pavement Marking
- ===== Barrier Pavement Marking
- - - - - Stripe 4 IN Dotted Extension White
- - - - - Stripe 8 IN Dotted Extension White
- - - - - Stripe 8 IN Lane Drop

Pavement Joints

- ===== Doweled Joint
- +++++ Tie Bar 30 Inch 4 Foot Center to Center
- +++++ Tie Bar 18 Inch 3 Foot Center to Center
- +++++ Tie Bar at Random Spacing

Bridge Details

- Small Hidden Object
- Large Hidden Object
- Phantom Object
- Existing Conditions Object
- Centerline Main
- Centerline Secondary
- Excavation Limits
- Proposed Ground
- Sheet Piling

Erosion Control

- Limits of Const Transition Line
- Bale Check
- Rock Check
- s ----- s ----- Floating Silt Curtain
- SF ----- SF ----- Silt Fence
- Excavation Limits
- Fiber Rolls







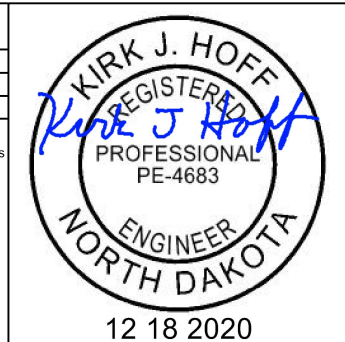



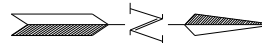

















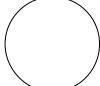







Environmental

- Wetland Mitigation
- Existing Wetland Easement USFWS
- Existing Wetland Jurisdictional
- Existing Wetland
- Tree Row

NORTH DAKOTA DEPARTMENT OF TRANSPORTATION	
07-01-14	
REVISIONS	
DATE	CHANGE
09-23-16	Added and Revised Items, Organized by Functional Groups General Revisions
12-18-20	



SYMBOLS

	North Arrow (Half Scale)		Existing Bush or Shrub		Continuous Split Barrel Sample
	Alignment Data Point		Existing Large Evergreen Tree		Flight Auger Sample
	Alignment Monument		Existing Small Evergreen Tree		Split Barrel Sample
	Spot Elevation		Existing Large Tree		Thinwall Tube Sample
	Existing Miscellaneous Spot		Existing Small Tree		Standard Penetration Test
	Existing Access Control Arrow		Existing Tree Trunk		Inclinometer Tube
	Existing Benchmark		Cairn or Stone Circle		Excavation Unit
	Reset USGS Marker		Existing Artifact		Existing Ground Water Well Bore Hole
	Iron Monument Found		Existing Satellite Dish		
	Iron Pin R/W Monument		Existing Weather Station		
	Property Corner		Existing Windmill or Tower		
	Iron Pin Reference Monument		Reinforced Pavement		
	Right of Way Marker (Exst, Ppsd, Reset)				
	Existing Federal Reference Corner				
	Existing Section Corner (Full, Quarter, Sixteenth, Meander)				
	Existing Witness Corner				
	Existing Control Point (CP, GPS-RTK, TRI)				
	Existing Traverse PI Aerial Panel				
	Existing Reference Marker Point NGS				
	Existing EFB Misc				

NORTH DAKOTA DEPARTMENT OF TRANSPORTATION	
07-01-14	
REVISIONS	
DATE	CHANGE
12-18-20	General Revisions































KIRK J. HOFF
REGISTERED
PROFESSIONAL
ENGINEER
NORTH DAKOTA
PE-4683

12 18 2020

SYMBOLS

D-101-31

















































































	Flexible Delineator		Highway Sign (Exst, Ppsd)
	Flexible Delineator Type A (Exst, Ppsd)		Mile Post Type A (Exst-Ppsd-Reset)
	Flexible Delineator Type B (Exst, Ppsd)		Mile Post Type B (Exst, Ppsd)
	Flexible Delineator Type C (Exst, Ppsd)		Mile Post Type C (Exst, Ppsd)
	Flexible Delineator Type D (Exst, Ppsd)		Object Marker Type I (Exst, Ppsd)
	Flexible Delineator Type E (Exst, Ppsd)		Object Marker Type II (Exst, Ppsd)
	Delineator Type A (Exst, Ppsd, Diamond Grade-Reset)		Object Marker Type III (Exst, Ppsd)
	Delineator Type B (Exst, Ppsd, Diamond Grade-Reset)		Existing Reference Marker
	Delineator Type C (Exst, Ppsd, Diamond Grade)		Road Closure Gate 18 Ft (Exst, Ppsd)
	Delineator Type D (Exst, Ppsd, Diamond Grade)		Road Closure Gate 28 Ft (Exst, Ppsd)
	Delineator Type E (Exst, Ppsd, Diamond Grade)		Road Closure Gate 40 Ft (Exst, Ppsd)
	Barricade (Type I, Type II, Type III)		Existing Railroad Battery Box
	Arrow Panel (Caution Mode, Double Direction, Left Directional, Right Directional, Sequencing, Truck Mounted)		Existing RR Profile Spot
	Attenuation Device		Existing Railroad Crossbuck
	Truck Mounted Attenuator		Existing Railroad Frog
	Delineator Drums		Existing Mailbox (Private, Federal)
	Flagger		
	Tubular Marker		
	Traffic Cone		
	Back to Back Vertical Panel Sign		

NORTH DAKOTA DEPARTMENT OF TRANSPORTATION		
07-01-14		
REVISIONS		
DATE	CHANGE	
12-18-20	General Revisions	

12 18 2020

SYMBOLS

D-101-32

 Existing Luminaire  Luminaire LED  Existing Light Standard Luminaire  Relocate Light Standard  Light Standard Light LED Luminaire  Light Standard 35 Watt High Pressure Sodium Vapor Luminaire  Light Standard 50 Watt High Pressure Sodium Vapor Luminaire  Light Standard 70 Watt High Pressure Sodium Vapor Luminaire  Light Standard 100 Watt High Pressure Sodium Vapor Luminaire  Light Standard 150 Watt High Pressure Sodium Vapor Luminaire  Light Standard 200 Watt High Pressure Sodium Vapor Luminaire  Light Standard 250 Watt High Pressure Sodium Vapor Luminaire  Light Standard 310 Watt High Pressure Sodium Vapor Luminaire  Light Standard 400 Watt High Pressure Sodium Vapor Luminaire  Light Standard 700 Watt High Pressure Sodium Vapor Luminaire  Light Standard 1000 Watt High Pressure Sodium Vapor Luminaire  Emergency Vehicle Detector  Video Detection Camera	  High Mast Light Standard 3 Luminaire (Exst, Ppsd)   High Mast Light Standard 4 Luminaire (Exst, Ppsd)   High Mast Light Standard 5 Luminaire (Exst, Ppsd)   High Mast Light Standard 6 Luminaire (Exst, Ppsd)   High Mast Light Standard 7 Luminaire (Exst, Ppsd)   High Mast Light Standard 8 Luminaire (Exst, Ppsd)   High Mast Light Standard 9 Luminaire (Exst, Ppsd)   High Mast Light Standard 10 Luminaire (Exst, Ppsd)   Overhead Sign Structure Load Center (Exst, Ppsd)   Traffic Signal Controller (Exst, Ppsd)   Pad Mounted Traffic Signal Controller (Exst, Ppsd)   Flashing Beacon (Exst, Ppsd)   Concrete Foundation (Exst, Ppsd)   Pipe Mounted Flasher (Exst, Ppsd)   Pad Mounted Feed Point (Exst, Ppsd)   Pipe Mounted Feed Point with Pad (Exst, Ppsd)   Pole Mounted Feed Point (Exst, Ppsd)   Junction Box (Exst, Ppsd)  Existing Pedestrian Head with Number  Existing Signal Head  Pole Mounted Head  Existing Lighting Standard Pole	 Existing Traffic Signal Standard    Pull Box (Exst-Ppsd-Undefined)   Intelligent Transportation Pull Box (Exst, Ppsd)   Transformer (Exst, Ppsd)    Power Pole (Exst-Ppsd-with Transformer)   Wood Pole (Exst, Ppsd)   Pedestrian Push Button Post (Exst, Ppsd)  Existing Pole  Existing Telephone Pole  Existing Post     Connection Conductor (Ground, Neutral, Phase 1, Phase 2)
---	---	--

NORTH DAKOTA DEPARTMENT OF TRANSPORTATION	
07-01-14	
REVISIONS	
DATE	CHANGE
12-18-20	General Revisions



KIRK J. HOFF

REGISTERED

PROFESSIONAL

PE-4683

ENGINEER

NORTH DAKOTA

12 18 2020

SYMBOLS

D-101-33

			Existing Manhole (Electrical, Gas, Telephone)			Cap or Stub Exst Gas, Exst Sanitary, Exst Storm Drain, Ppsd Storm Drain, Exst Water	
			Water Manhole (Exst, Exst with Valve)				
			Sanitary Sewer Manhole (Exst, Ppsd, Exst with Valve)		Existing Pedestal Electrical, Telephone, Fiber Optic Telephone, TV, Fiber Optic TV, Undefined		
			Sanitary Force Main Manhole (Exst, Ppsd, Exst with Valve)				
			Storm Drain Manhole (Exst, Ppsd, Exst with Inlet, Ppsd with Inlet)		Existing Pipe Vent Gas, Fuel, Sanitary, Storm Drain, Water, Undefined		
			Force Main Storm Drain Manhole (Exst, Exst with Valve)				
			Manhole (Ppsd, Ppsd 48 Inch, Exst Undefined)		Valve Exst Gas, Exst Water, Ppsd Water, Exst Undefined		
			Existing Water Appurtenance				
			Sprinkler Head (Exst, Ppsd)		Pump Sanitary, Storm Drain, Exst Water		
			Fire Hydrant (Exst, Ppsd)				
			Cleanout (Exst Sanitary, Underdrain)		Corrugated Metal End Section (18, 24, 30, 36, 42, 48, 54, 60 Inch)		
			Existing Catch Basin Inlet (Round, Square)				
			Existing Curb Inlet (Round, Square)		Reinforced Concrete End Section (18, 24, 30, 36, 42, 48, 54, 60 Inch)		
			Existing Slotted Reinforced Concrete Pipe				
			Catch Basin (Riser 30 Inch, Beehive, Type A)		Existing Utility Marker		
			Inlet Mountable Curb (Type A, Type B)		Existing Meter		
			Inlet Saddle Base (Type 1, Type 2)		Existing Fuel Dispensers		
			Inlet Special (Catch Basin, Type 1, Type A)		Existing Fuel Filler Pipes		
			Inlet (Tee, Type 1, Type 2, Type 2 Double)		Existing Fuel Leak Sensors		
			Median Drain				
			Headwall (Exst, Ppsd, Ppsd Single with Vegetation Barrier, Ppsd Double with Vegetation Barrier)				

NORTH DAKOTA DEPARTMENT OF TRANSPORTATION	
07-01-14	
REVISIONS	
DATE	CHANGE
12-18-20	General Revisions Sheet added - Continued from D-101-32



KIRK J. HOFF
REGISTERED
PROFESSIONAL
ENGINEER
NORTH DAKOTA
12 18 2020

BREAKAWAY SYSTEMS FOR CONSTRUCTION ZONE SIGNS

D-704-7

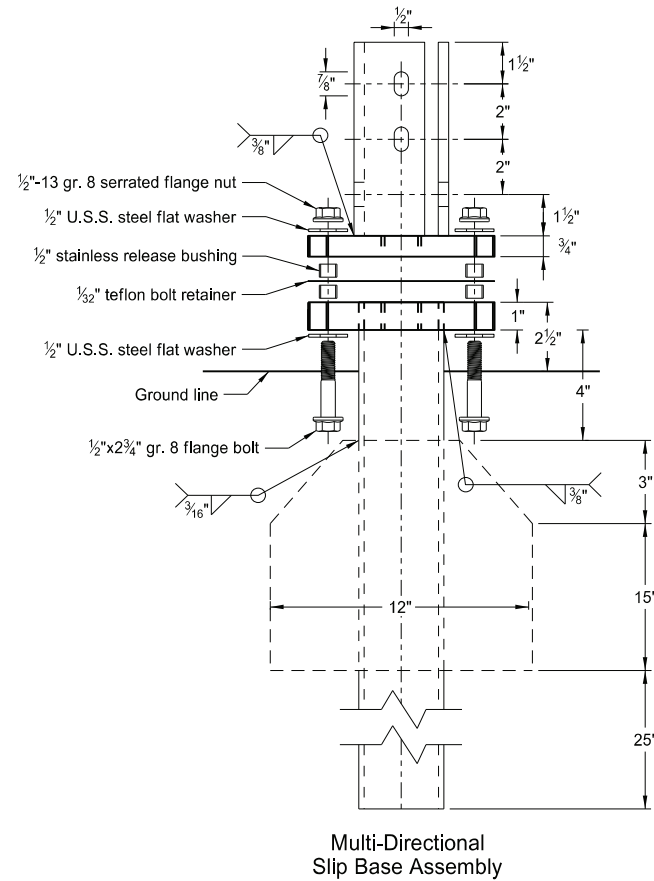

Perforated Tube

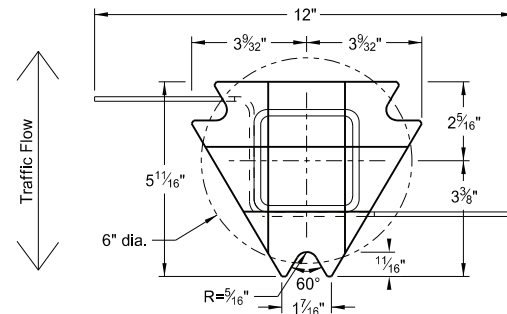
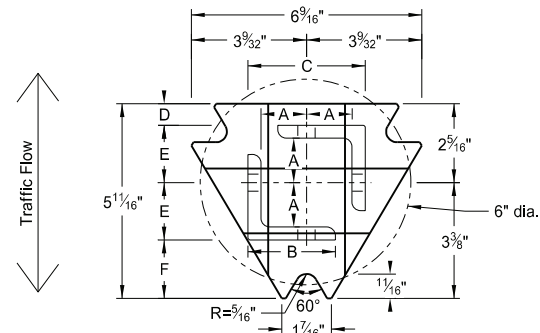

Notes:

1. Torque slip base bolts as specified by manufacturer.
2. Use anchor with 43.9 KSI yield strength and 59.3 KSI tensile strength.
3. Provide 4" vertical clearance for anchor or breakaway base. Measure the 4"x60" measurement above and below post location and back and ahead of post.
4. In concrete sidewalk, use same anchor without wings.
5. Provide more than 7' between the first and fourth posts of a four post sign.

Telescoping Perforated Tube

Number of Posts	Post Size in.	Wall Thickness Gauge	Sleeve Size in.	Wall Thickness Gauge	Slip Base	Anchor Size without Slip Base in.
1	2	12			No	2 1/4
1	2 1/4	12			No	2 1/2
1	2 1/2	12			(A)	3
1	2 1/2	10			Yes	
1	2 1/4	12	2	12	Yes	
1	2 1/2	12	2 1/4	12	Yes	
2	2	12			No	2 1/4
2	2 1/4	12			No	2 1/2
2	2 1/2	12			Yes	
2	2 1/2	12			Yes	
2	2 1/4	10	2	12	Yes	
3 & 4	2 1/2	12			Yes	
3 & 4	2 1/2	10			Yes	
3 & 4	2 1/2	12	2 1/4	12	Yes	
3 & 4	2 1/4	12	2	12	Yes	
3 & 4	2 1/2	10	2 3/16	10	Yes	

Properties of Telescoping Perforated Tube

Tube Size in.	Wall Thickness in.	U.S. Standard Gauge	Weight per Foot lbs.	Moment of Inertia in. ⁴	Cross Sec. Area in. ²	Section Modulus in. ³
1 1/2 x 1 1/2	0.105	12	1.702	0.129	0.380	0.172
2 x 2	0.105	12	2.416	0.372	0.590	0.372
2 1/4 x 2 1/4	0.105	12	2.773	0.561	0.695	0.499
2 3/16 x 2 3/16	0.135	10	3.432	0.605	0.841	0.590
2 1/2 x 2 1/2	0.105	12	3.141	0.804	0.803	0.643
2 1/2 x 2 1/2	0.135	10	4.006	0.979	1.010	0.785

Top Post Receiver Data Table

Square Post Sizes (B)	A	B	C	D	E	F
2 3/16"x10 ga.	1 5/64"	2 1/2"	3 1/32"	2 5/32"	1 33/64"	1 7/8"
2 1/2"x10 ga.	1 3/32"	2 1/2"	3 5/16"	5/8"	1 21/32"	1 3/4"

(A) Use breakaway base when support is placed in weak soils. Engineer determines if soils are weak.

(B) For additional wind load, insert the 2 3/16"x10 ga. into 2 1/2"x10 ga.

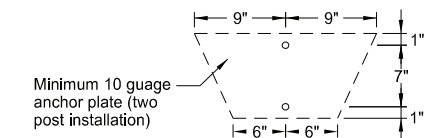
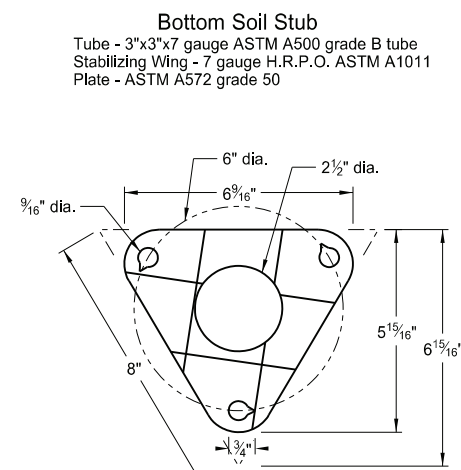
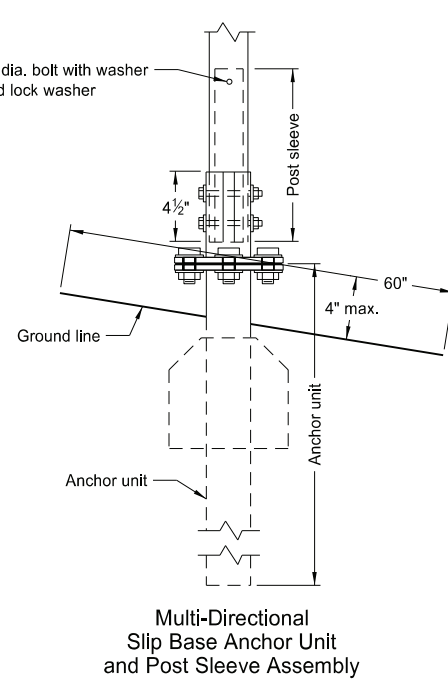
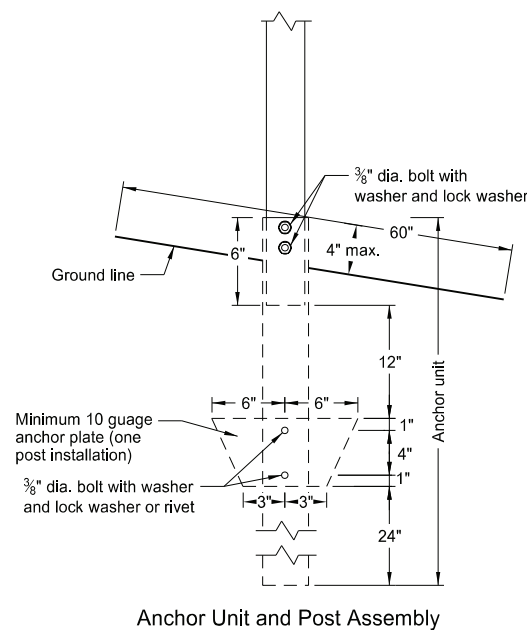

NORTH DAKOTA DEPARTMENT OF TRANSPORTATION	
2-28-14	
REVISIONS	
DATE	CHANGE
9-27-17	Updated to active voice
10-03-19	New Design Engr PE Stamp
8-01-24	Electronic Stamp/Signature



08/01/24

BREAKAWAY SYSTEMS FOR CONSTRUCTION ZONE SIGNS

D-704-8

U-Channel Post

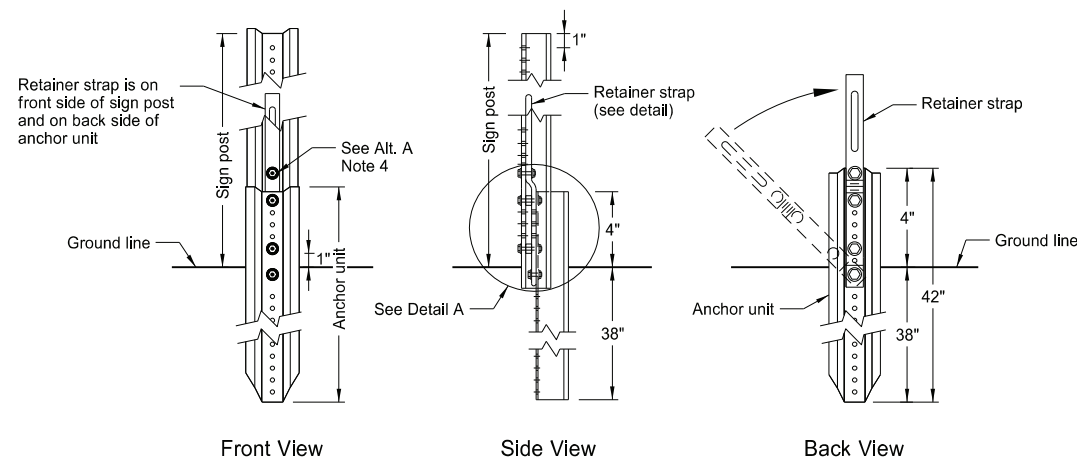
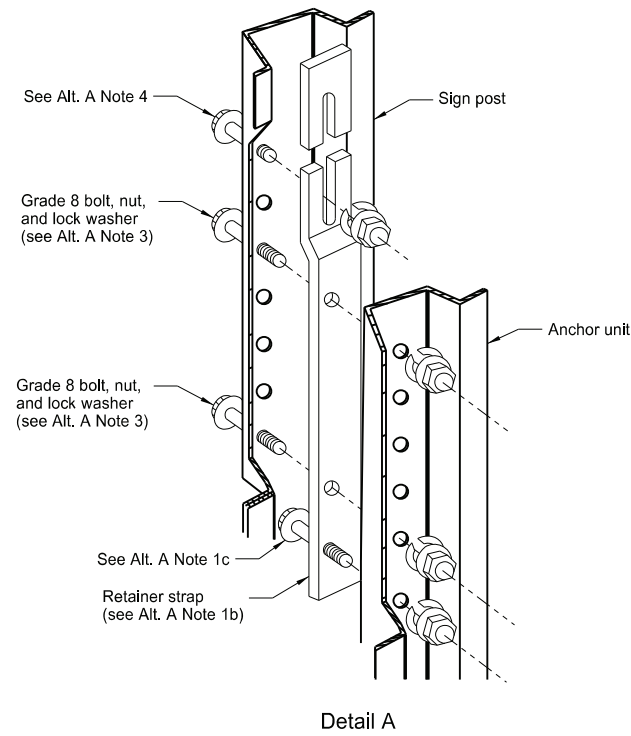

Breakaway U-Channel Detail Alternate A
Install a maximum of 2 posts within 7'.

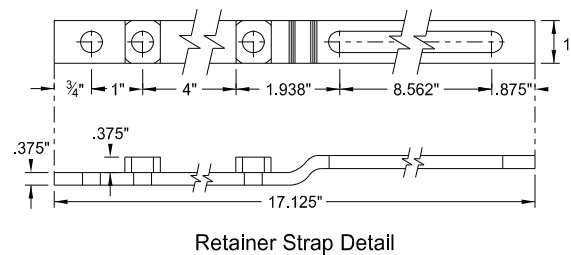

Retainer Strap Detail

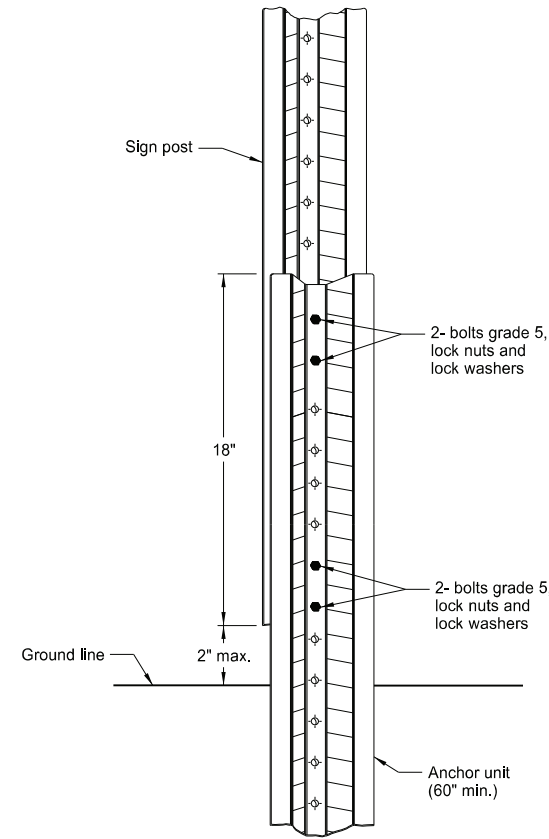

Breakaway U-Channel Splice Detail Alternate B
(2.5 and 3 lb/ft)
Install a maximum of 3 posts within 7'.

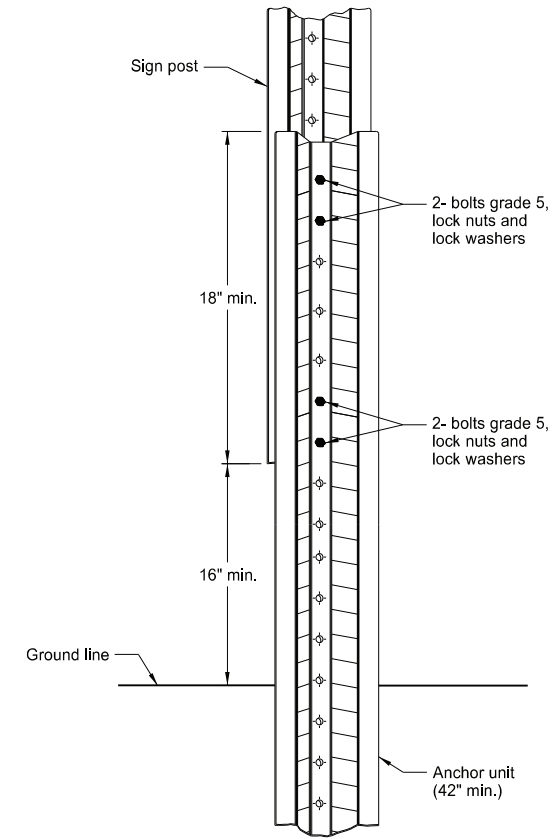

Breakaway U-Channel Splice Detail Alternate C
(2.5 and 3 lb/ft)
Install a maximum of 3 posts within 7'.

Alternate A Steps of Installation:

- Drive anchor unit to within 12" of ground level.
 - Establish proper assembly by lining up bottom hole of retainer strap with 6th hole from the top of the anchor unit.
 - Assemble strap to back of anchor unit using 5/16"x2" bolt, lock washer and nut.
 - Rotate strap 90° to left.
- Drive anchor unit to 4" above ground.
 - Rotate strap to vertical position.
- Place 5/16"x2" bolt, lock washer and nut in bottom of sign post to facilitate alignment of sign post with proper hole in anchor unit.
 - Alternately tighten two connector bolts.
- Complete assembly by tightening 5/16"x2" bolt (this fastens sign post to retainer strap).
- Properly nest base post, strap, and sign post. Proper nesting occurs when all flat surfaces of the base post, strap, and sign post at the bolts have full contact across the entire width.

NORTH DAKOTA DEPARTMENT OF TRANSPORTATION	
2-28-14	
REVISIONS	
DATE	CHANGE
9-27-17	Updated to active voice
10-03-19	New Design Engr PE Stamp
8-01-24	Electronic Stamp/Signature



08/01/24

CONSTRUCTION SIGN DETAILS
TERMINAL AND GUIDE SIGNS

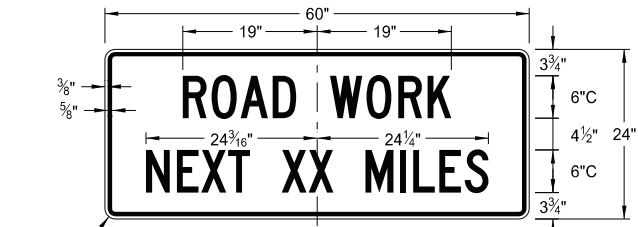

G20-1-60
Legend: black (non-refl)
Background: orange

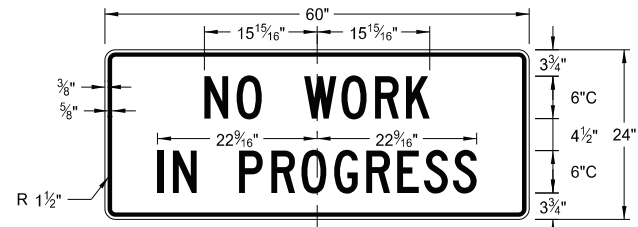

G20-1b-60
Legend: black (non-refl)
Background: orange

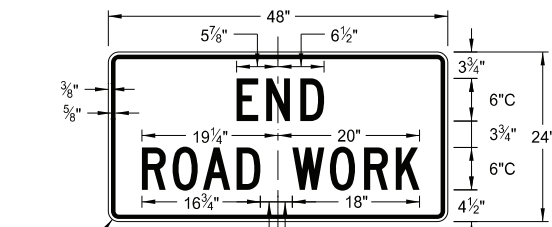

G20-2-48
Legend: black (non-refl)
Background: orange

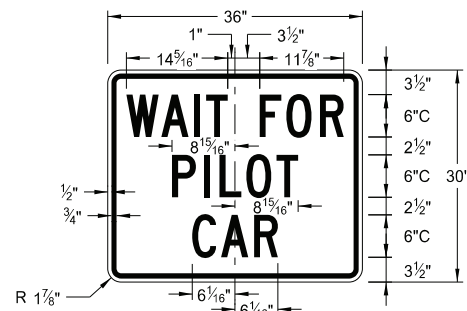

G20-4b-36
Legend: black (non-refl)
Background: orange

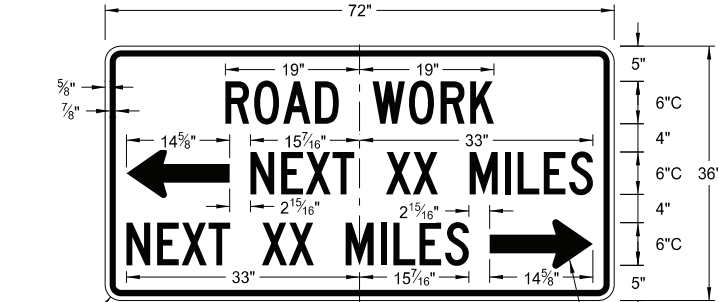

G20-50a-72
Legend: black (non-refl)
Background: orange

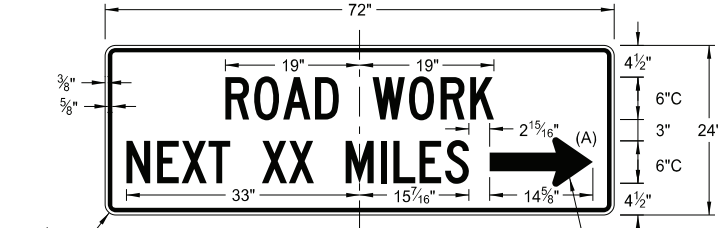

G20-52a-72
Legend: black (non-refl)
Background: orange

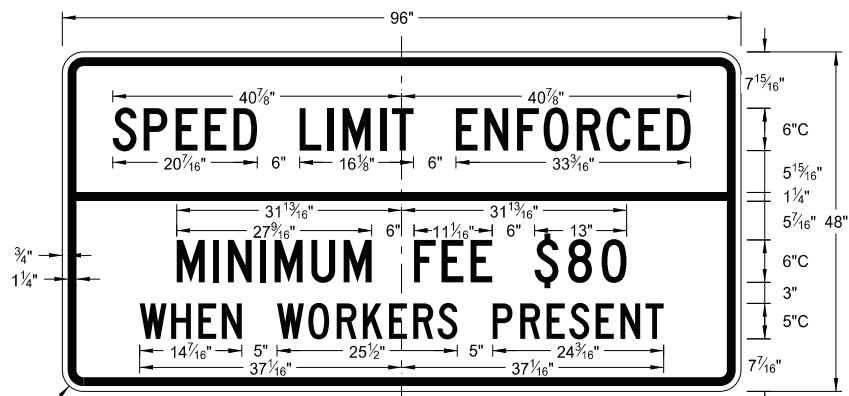

G20-55-96
Legend: black (non-refl)
Background: orange

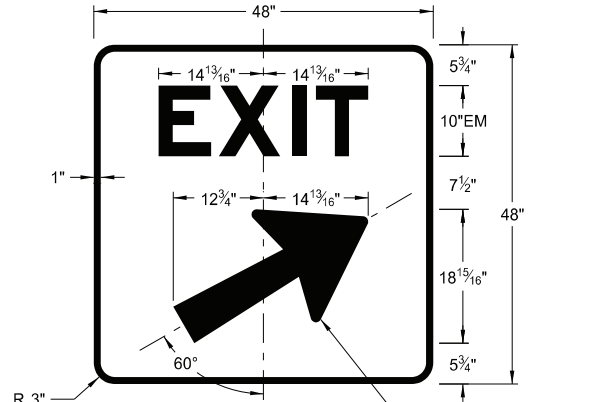

E5-1(L or R)-48
Legend: white
Background: green (orange optional)

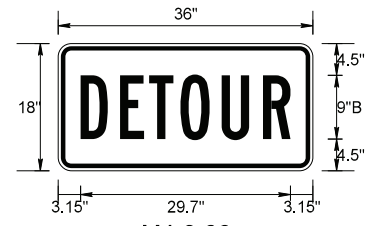

M4-8-36
Legend: black (non-refl)
Background: orange

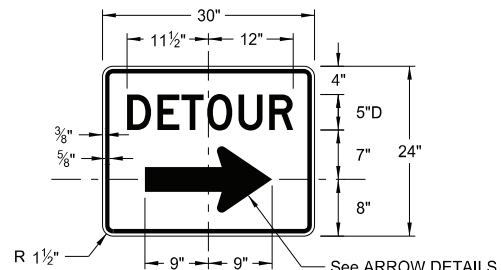

M4-9(L or R)-30 & M4-9-30
Legend: black (non-refl)
Background: orange

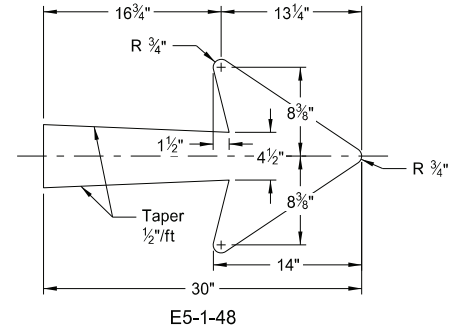

E5-1-48

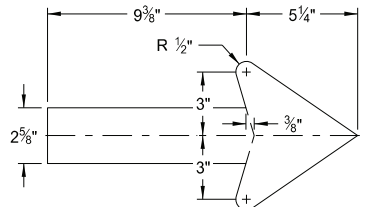

G20-50a-72
G20-52a-72

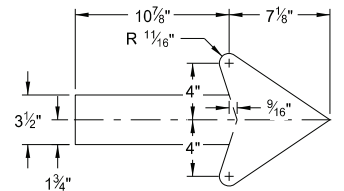

M4-9(L or R)-30
Right or Left

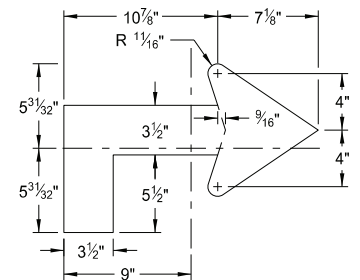

M4-9(L or R)-30
Advanced Right or Left

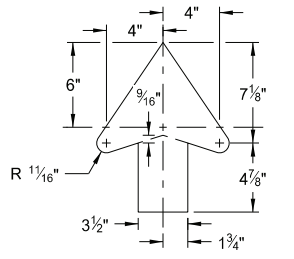

M4-9-30
Straight

ARROW DETAILS

NOTES:

(A) Arrow may be right or left of the legend to indicate construction to the right or left.

NORTH DAKOTA DEPARTMENT OF TRANSPORTATION 8-13-13	
REVISIONS	
DATE	CHANGE
8-17-17	Added sign & background color
10-03-19	New Design Engineer PE Stamp
8-01-24	Electronic Stamp/Signature



08/01/24

CONSTRUCTION SIGN DETAILS
REGULATORY SIGNS

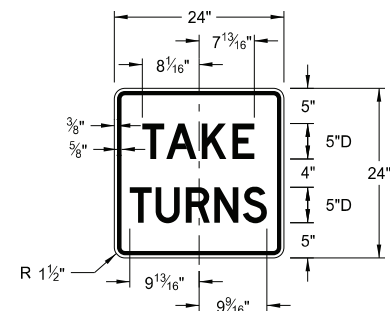

R1-50P-24
Legend: black (non-refl)
Background: white



R11-3c-60
Legend: black (non-refl)
Background: white

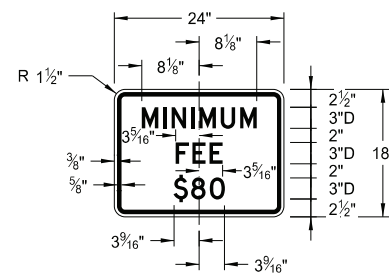

R2-1aP-24
Legend: black (non-refl)
Background: white

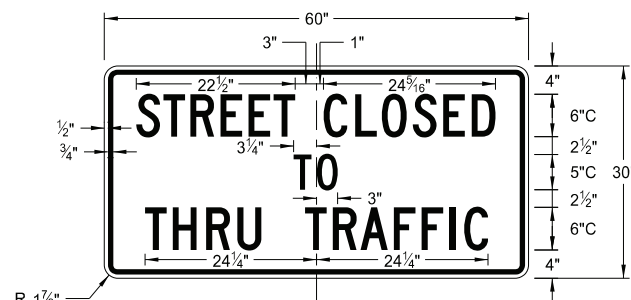

R11-4a-60
Legend: black (non-refl)
Background: white

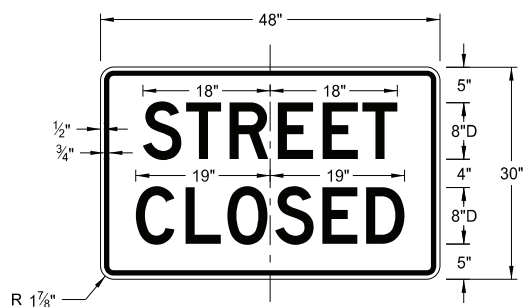

R11-2a-48
Legend: black (non-refl)
Background: white

NORTH DAKOTA DEPARTMENT OF TRANSPORTATION	
8-13-13	
REVISIONS	
DATE	CHANGE
8-17-17	Revised sign number
10-03-19	New Design Engineer PE Stamp
8-01-24	Electronic Stamp/Signature



08/01/24

CONSTRUCTION SIGN DETAILS
WARNING SIGNS

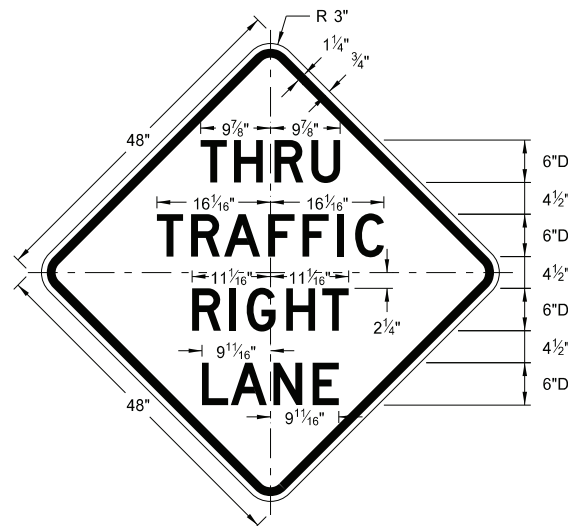

W5-8-48
Legend: black (non-refl)
Background: orange

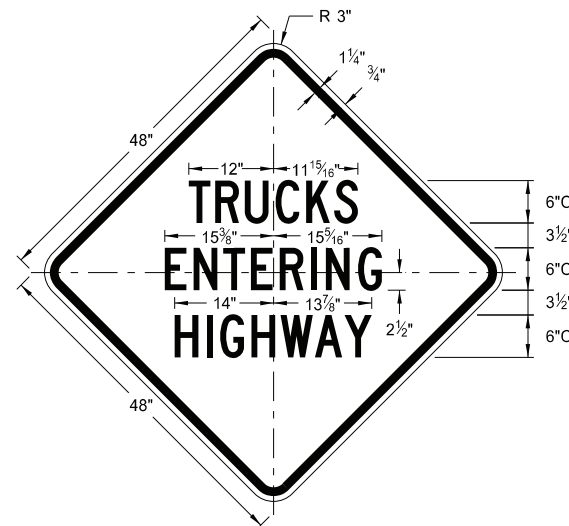

W8-53-48
Legend: black (non-refl)
Background: orange

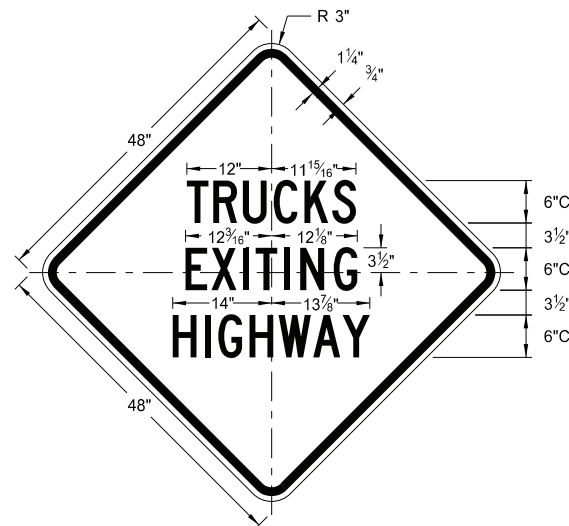

W8-56-48
Legend: black (non-refl)
Background: orange

WORD	LETTER SPACING
AHEAD	Standard
200 FT	Standard
350 FT	Standard
500 FT	Standard
1000 FT	Reduce 40%
1500 FT	Reduce 40%
½ MILE	Reduce 50%
1 MILE	Standard

* DISTANCE MESSAGES

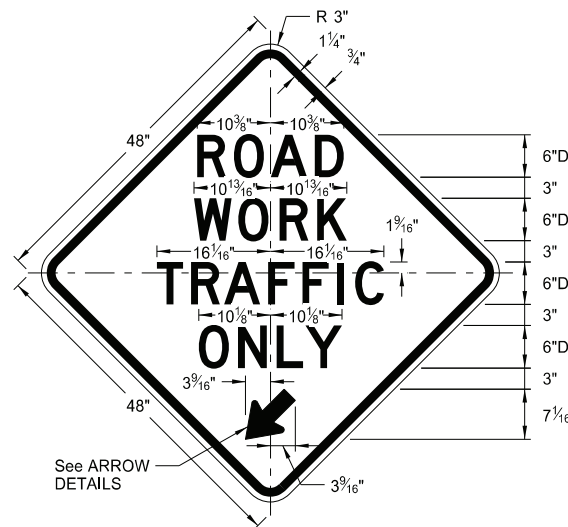

W5-9-48
Legend: black (non-refl)
Background: orange

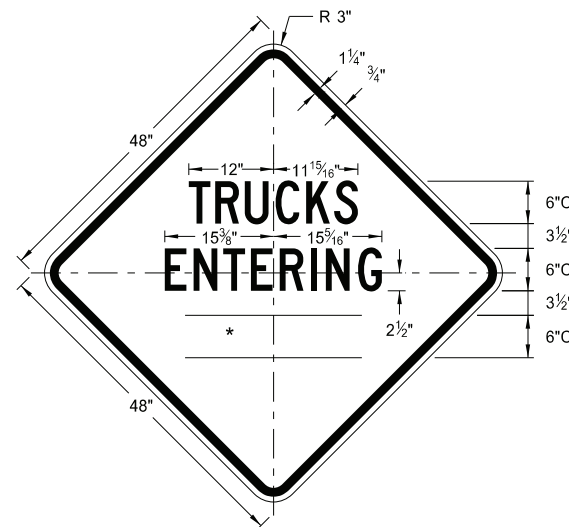

W8-54-48
Legend: black (non-refl)
Background: orange

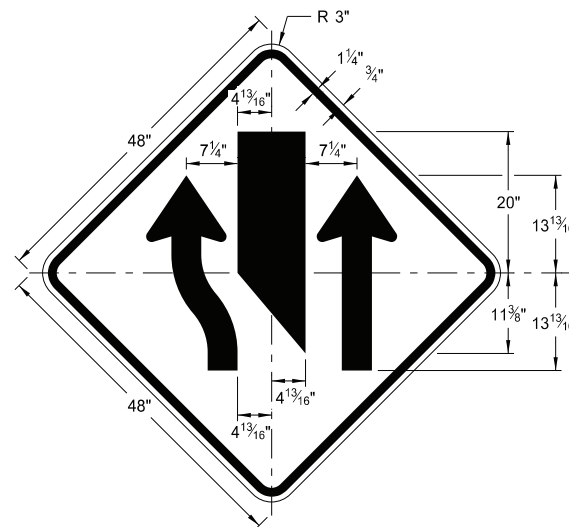

W9-3a-48
Legend: black (non-refl)
Background: orange

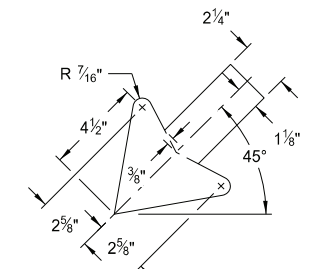

W5-9-48

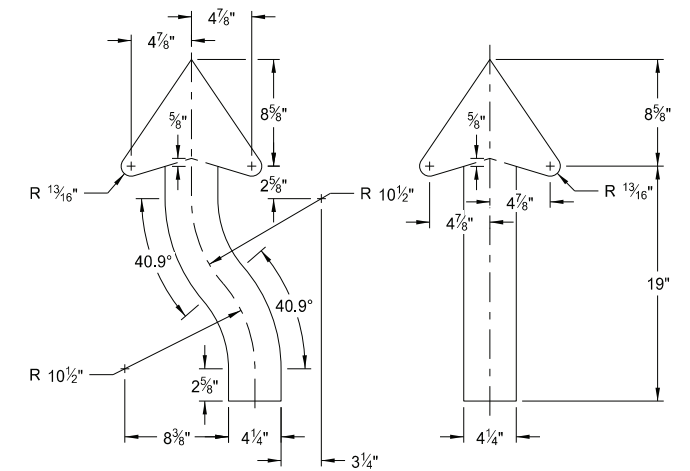

W9-3a-48

ARROW DETAILS

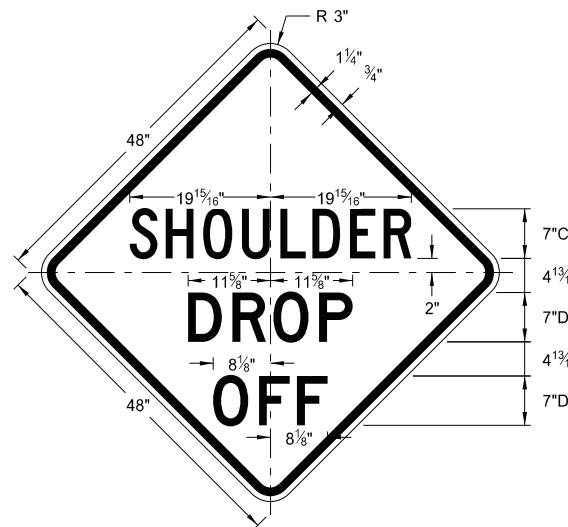

W8-9a-48
Legend: black (non-refl)
Background: orange

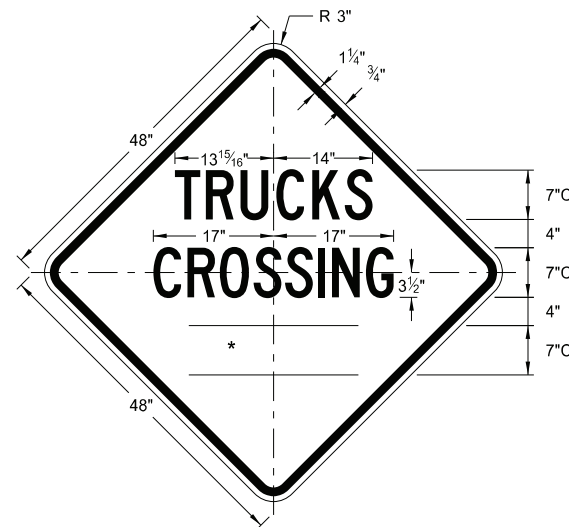

W8-55-48
Legend: black (non-refl)
Background: orange

NORTH DAKOTA DEPARTMENT OF TRANSPORTATION	
8-13-13	
REVISIONS	
DATE	CHANGE
8-17-17	Updated sign number
5-31-18	Revised sign and arrow details
10-03-19	New Design Engineer PE Stamp
8-01-24	Electronic Stamp/Signature



08/01/24

CONSTRUCTION SIGN DETAILS
WARNING SIGNS

WORD	LETTER SPACING
AHEAD	Standard
200 FT	Standard
350 FT	Standard
500 FT	Standard
1000 FT	Reduce 40%
1500 FT	Reduce 40%
½ MILE	Reduce 50%
1 MILE	Standard

* DISTANCE MESSAGES

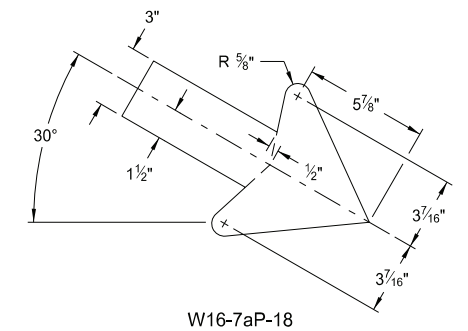

W16-7aP-18
Legend: black (non-refl)
Background: orange

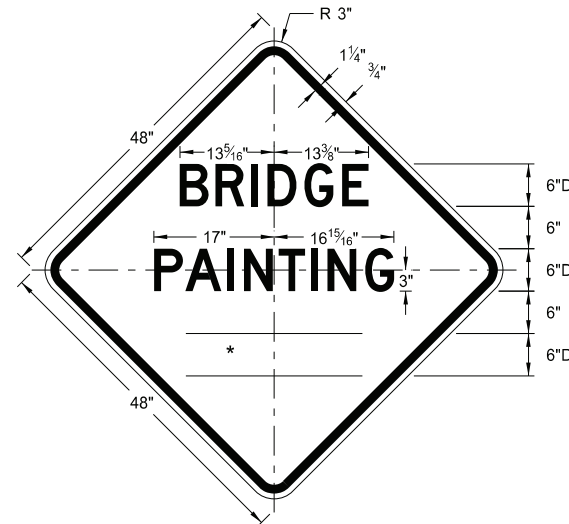

W21-50-48
Legend: black (non-refl)
Background: orange

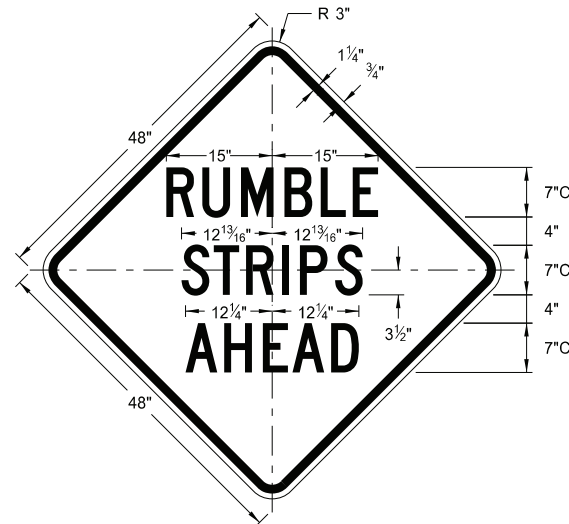

W21-53-48
Legend: black (non-refl)
Background: orange

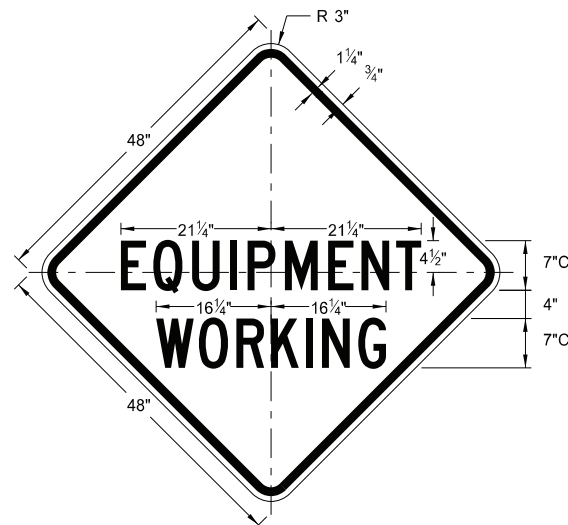

W20-51-48
Legend: black (non-refl)
Background: orange

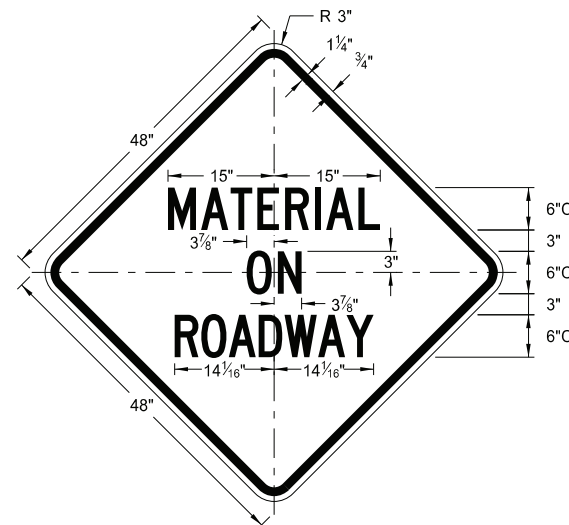

W21-51-48
Legend: black (non-refl)
Background: orange

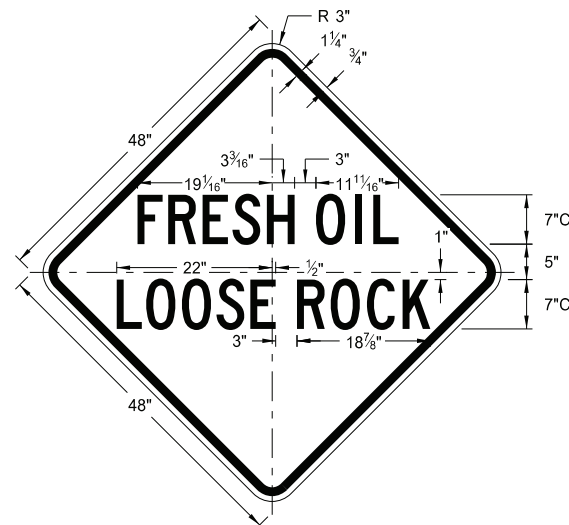

W22-8-48
Legend: black (non-refl)
Background: orange

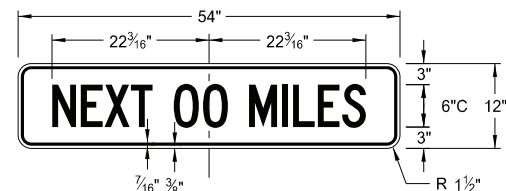

W20-52P-54
Legend: black (non-refl)
Background: orange

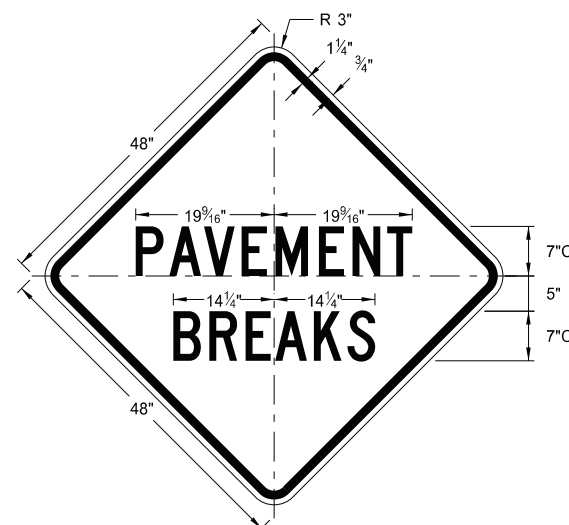

W21-52-48
Legend: black (non-refl)
Background: orange

NORTH DAKOTA DEPARTMENT OF TRANSPORTATION	
5-31-18	
REVISIONS	
DATE	CHANGE
11-01-19	Added details for sign W16-7aP-18.
8-01-24	Electronic Stamp/Signature.



08/01/24

BARRICADE AND CHANNELIZING DEVICE DETAILS

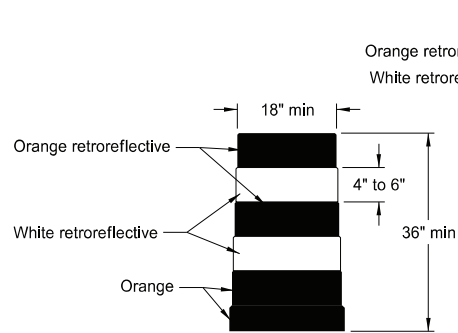

DELINEATOR DRUM

Provide horizontal, circumferential, alternating orange and white retroreflective stripes 4" to 6" wide for drum markings. Use a minimum of two orange and two white stripes with the top stripe being orange for each drum. Do not exceed 3" nonretroreflective spaces between the horizontal orange and white stripes. Avoid placement of stripes on drum ribs or indentations. Use closed top drums that will not allow collection of debris. Do not place ballast on the top of drum.

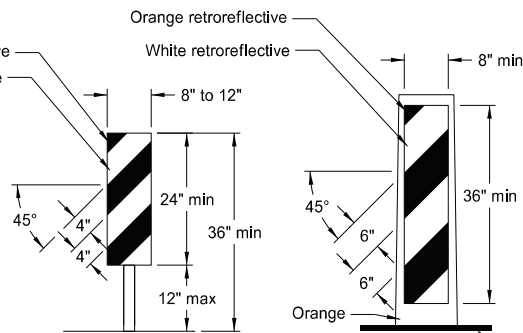

VERTICAL PANEL

Provide alternating orange and white retroreflective stripes, sloping downward in direction vehicular traffic is to pass. Place retroreflective sheeting on both sides of panel with a minimum of 270 square inches of retroreflective area facing vehicular traffic. Where the height of the retroreflective material on the vertical panel is 36 inches or more, use a stripe width of 6 inches.

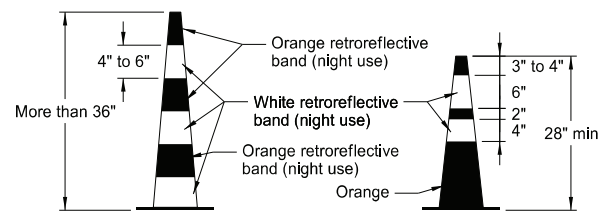

TRAFFIC CONE

Provide retroreflective cones more than 36" in height by alternating orange and white retroreflective stripes. Use a minimum of two orange and two white stripes for each cone with the top stripe being orange. Use maximum 3" nonretroreflective space between the orange and white stripes.

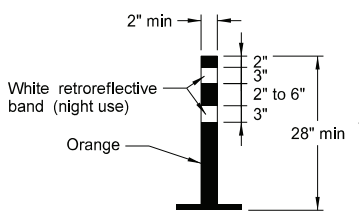

TUBULAR MARKER

Provide retroreflective tubular markers more than 42" in height by alternating four 4" to 6" wide orange and white stripes with the top stripe being orange.

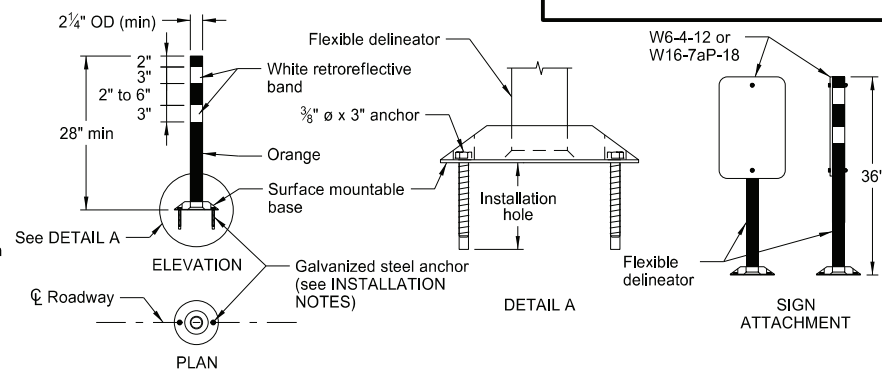

FLEXIBLE DELINEATOR

INSTALLATION NOTES:

1. Drill installation holes to diameter and depth required by manufacturer's specifications.
2. For removal, remove anchors and fill installation hole with an epoxy designed to bond to pavement surface.
3. In lieu of bolted down base, use an 8" x 8" butyl pad or hot melt butyl. Remove butyl as close as possible to pavement surface.

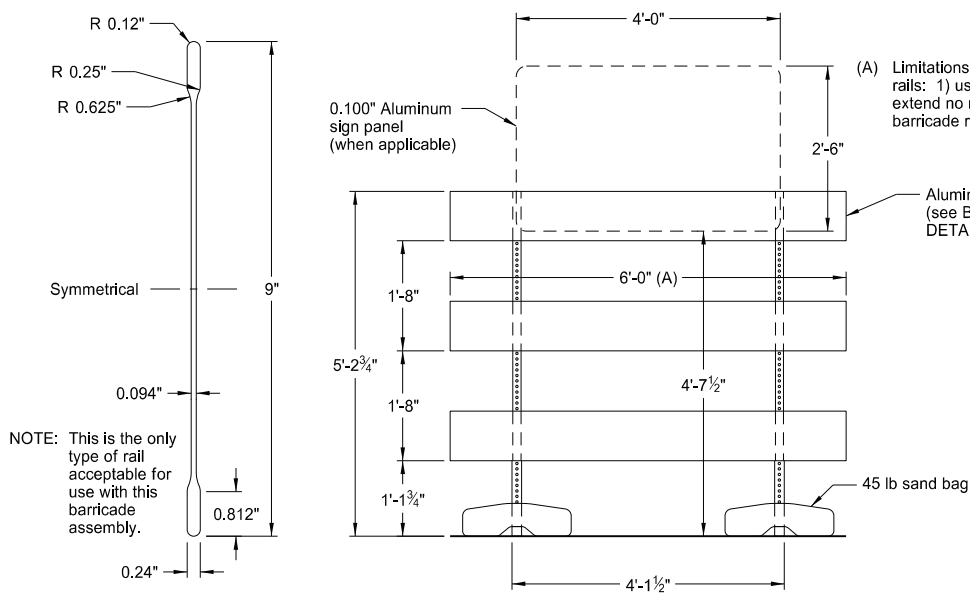

BARRICADE BLADE DETAIL

NOTE: This is the only type of rail acceptable for use with this barricade assembly.

ELEVATION VIEW

BARRICADE ASSEMBLY DETAIL (Aluminum Barricade Rails)

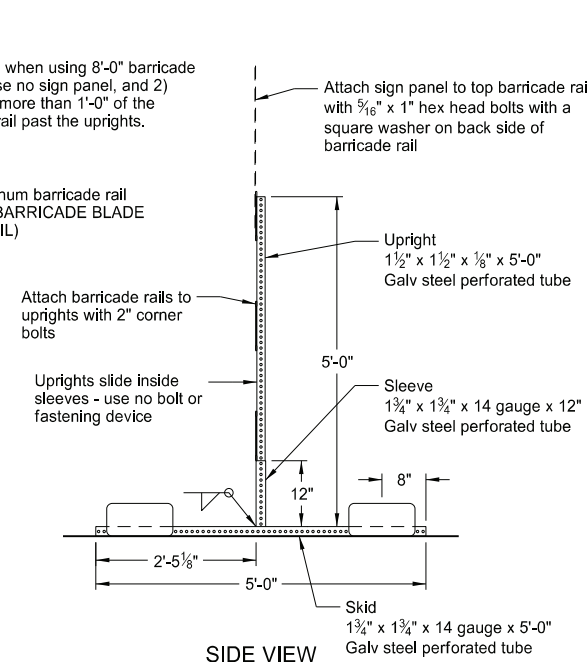

SIDE VIEW

TYPE II BARRICADE

BARRICADE RAIL DETAILS

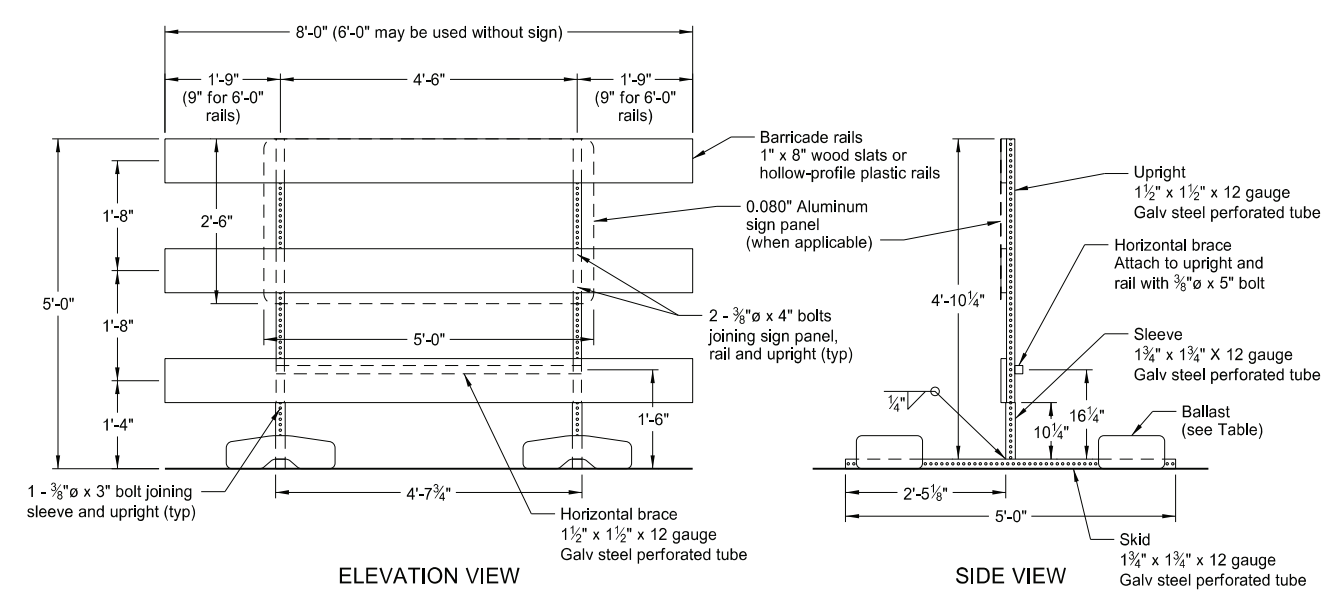

ELEVATION VIEW

BARRICADE ASSEMBLY DETAIL (Wood or Plastic Rails)

SIDE VIEW

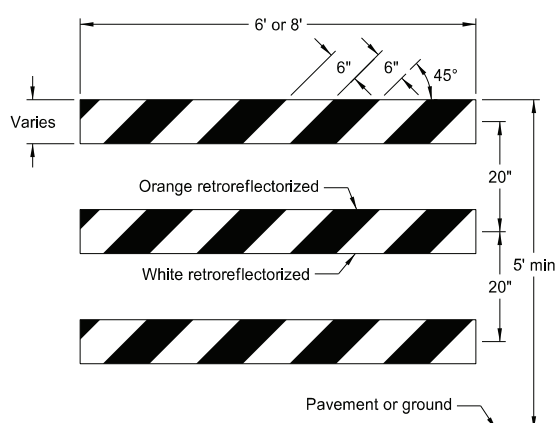

TYPE III BARRICADE

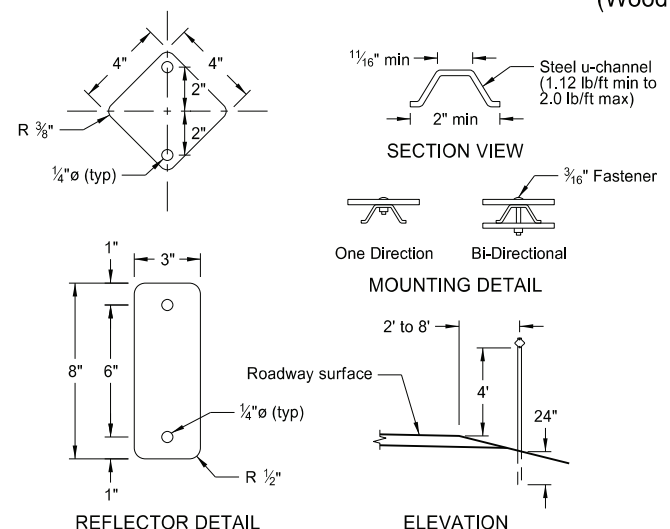

REFLECTOR DETAIL

ELEVATION

DELINEATORS

MINIMUM BALLAST (For each side of barricade support)

Without Sign	4 - 25 lb sandbags
With Sign	6 - 25 lb sandbags

Note: Number of sandbags based on a wind speed of 55 MPH. Sandbags assumed to be placed at or near the ends of the skids.

NORTH DAKOTA DEPARTMENT OF TRANSPORTATION	
10-3-13	
REVISIONS	
DATE	CHANGE
9-27-17	Updated to active voice
11-01-19	Revised details for Flexible Delineator
8-01-24	Electronic Stamp/Signature



08/01/24

CONSTRUCTION SIGN PUNCHING AND MOUNTING DETAILS

Note: In curb sections, place signs a minimum horizontal distance of 2' from face of the curb to near edge of the sign.

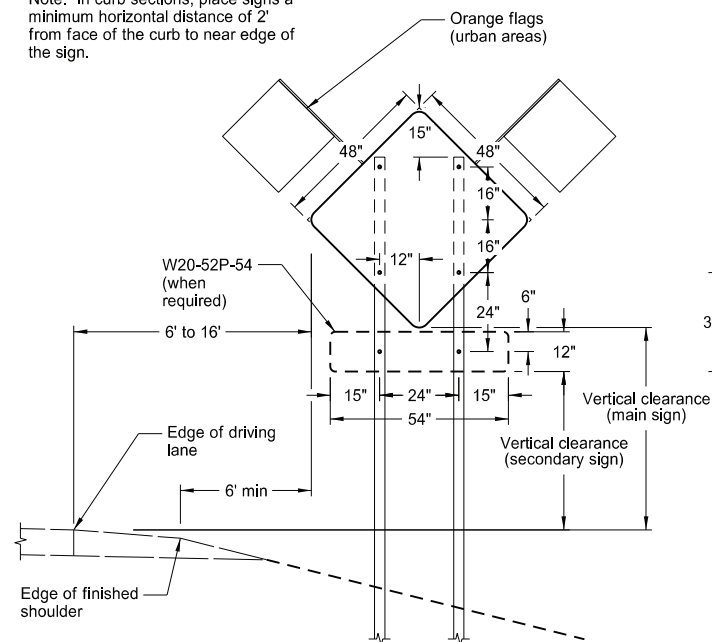

TYPICAL SECTION
(48" x 48" diamond warning sign shown)

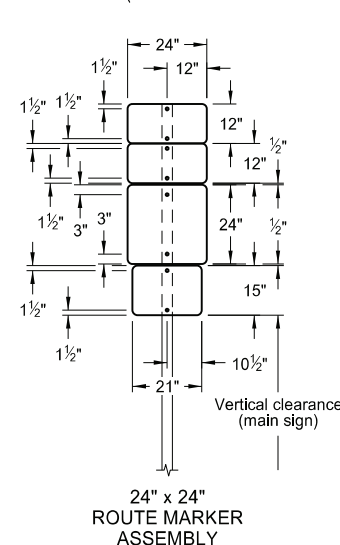

24" x 24" ROUTE MARKER ASSEMBLY

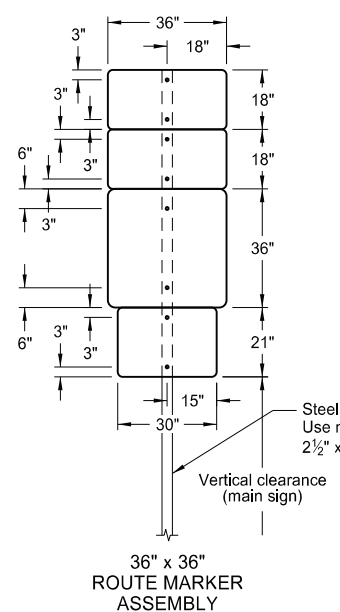

36" x 36" ROUTE MARKER ASSEMBLY

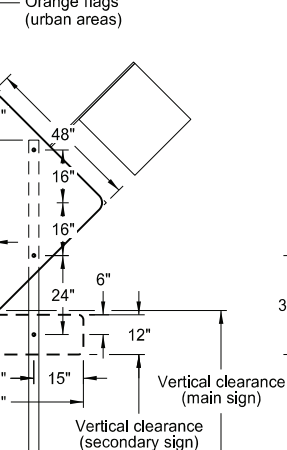

18" x 18" DIAMOND SIGN

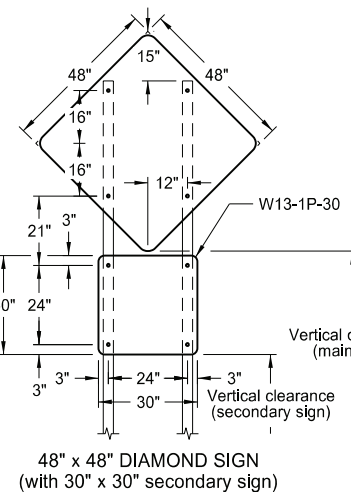

48" x 48" DIAMOND SIGN (with 30" x 30" secondary sign)

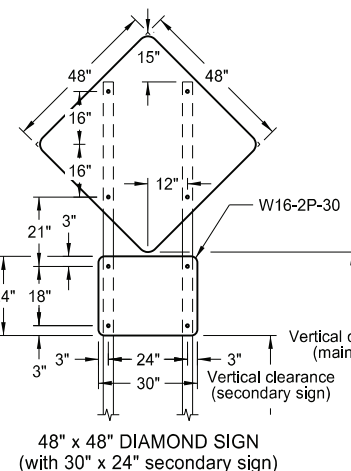

48" x 48" DIAMOND SIGN (with 30" x 24" secondary sign)

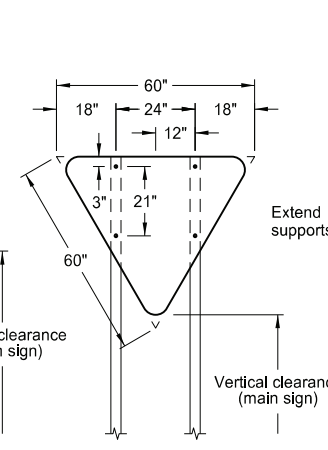

R1-2-60 - YIELD SIGN

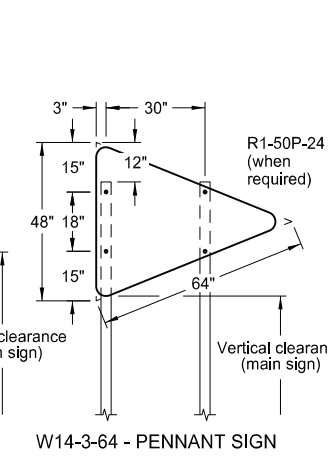

W14-3-64 - PENNANT SIGN

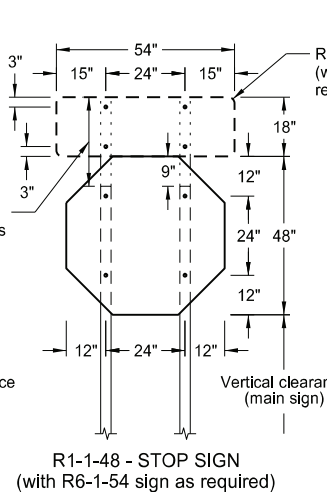

R1-1-48 - STOP SIGN (with R6-1-54 sign as required)

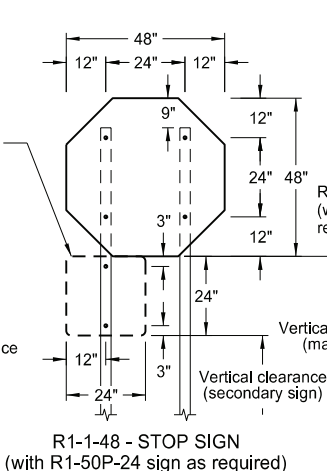

R1-1-48 - STOP SIGN (with R1-50P-24 sign as required)

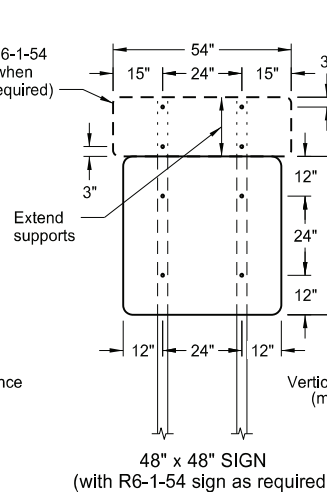

48" x 48" SIGN (with R6-1-54 sign as required)

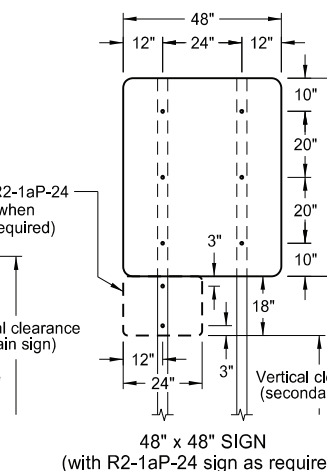

48" x 48" SIGN (with R2-1aP-24 sign as required)

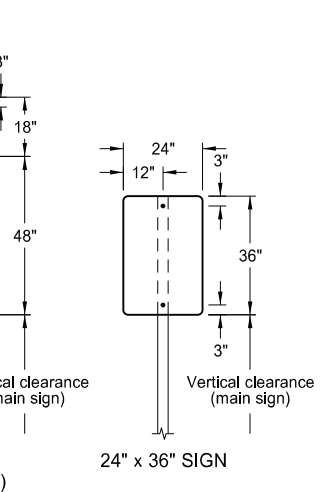

24" x 36" SIGN

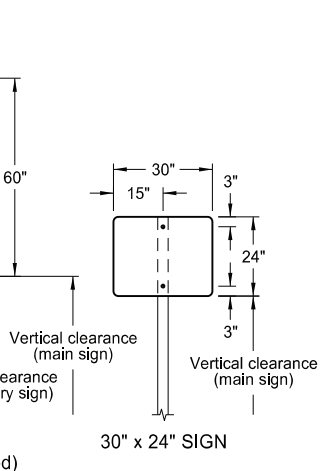

30" x 24" SIGN

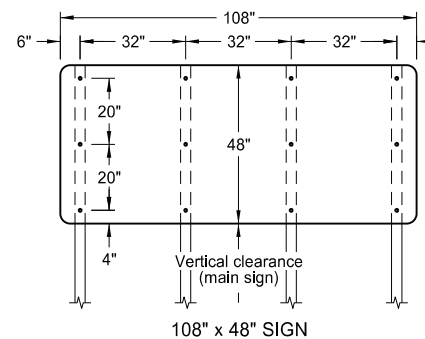

108" x 48" SIGN

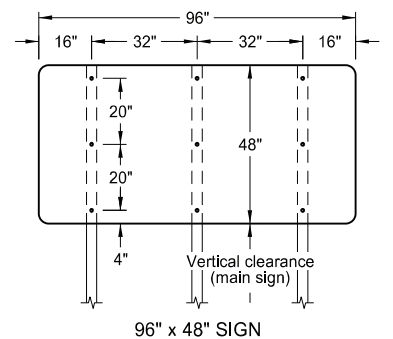

96" x 48" SIGN

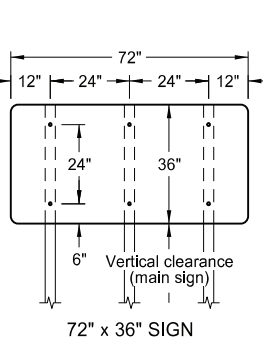

72" x 36" SIGN

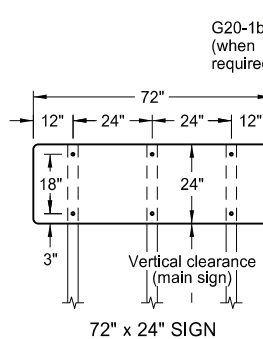

72" x 24" SIGN

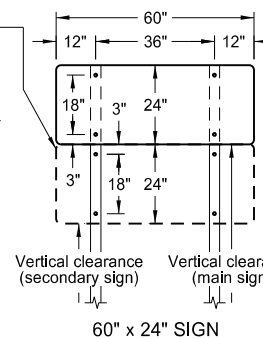

60" x 24" SIGN

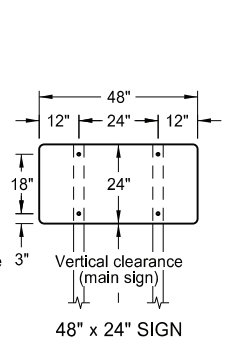

48" x 24" SIGN

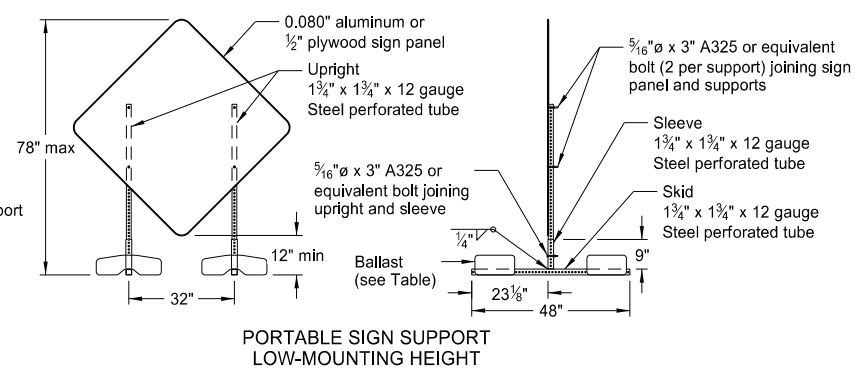

PORTABLE SIGN SUPPORT LOW-MOUNTING HEIGHT

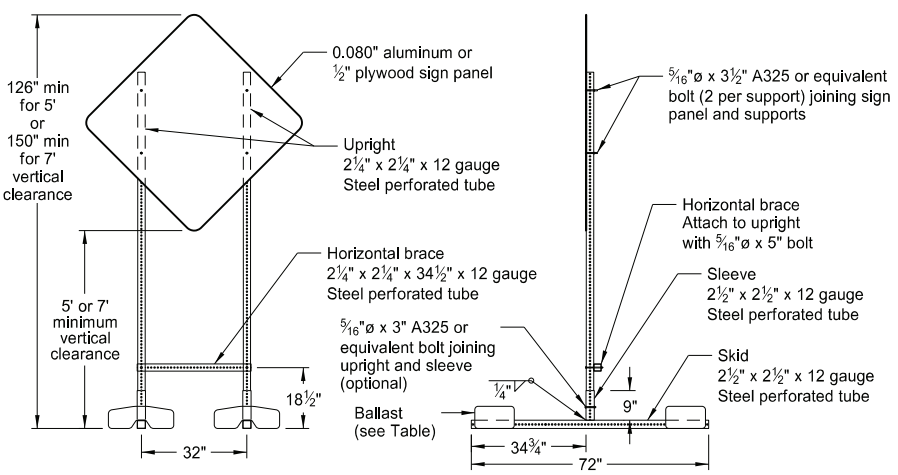

PORTABLE SIGN SUPPORT HIGH-MOUNTING HEIGHT

NOTES:

- Sign Supports: Galvanize or paint supports. Minimum post sizes are 2.5 lb/ft u-channel or 2" x 2" x 12 gauge steel perforated tube, except where noted. When installing signs on u-channel, minimum post size for assemblies containing a secondary sign is 3.0 lb/ft. Post sizes based on a wind speed of 55 MPH.
Place signs over 50 square feet on 2 1/2" x 2 1/2" perforated tube supports as a minimum.
Do not attach guy wires to sign supports. Attach wind beams behind sign panels when used with u-posts.
- Sign Panels: Provide sign panels made of 0.100" aluminum, 1/2" plywood, or other approved material, except where noted. Punch all holes round for 3/8" bolts.
- Alternate Messages: Install and remove alternate message signs on reflectorized plate (without borders) as required. (i.e. "Left" and "Right" message on lane closure sign)
- Route Marker Auxiliary Signs: Provide route marker auxiliary signs, such as the cardinal direction and directional arrows, with a background and legend that match the route marker they are used with:
Interstate - white legend on blue background
Interstate Business Loop - white legend on green background
US and State - black legend on white background
County - yellow legend on blue background
- Vertical Clearance: Install signs with a vertical clearance of 5'-0" (see TYPICAL SECTION.) In areas where parking or pedestrian movements are likely or the view of the sign may be obstructed, install signs with a vertical clearance of 7'-0" from the top of the curb or from the near edge of the driving lane in absence of a curb.
The vertical clearance to secondary signs is 1'-0" less than the vertical clearance stated above.
Provide a minimum clearance of 7'-0" from the ground at the post for signs with an area exceeding 50 square feet.
- Portable Signs: Provide portable signs that meet the vertical clearance stated above when it is necessary to place signs within the pavement surface.
Use of low-mounting height (minimum 12" vertical clearance) portable signs for 5 days or less, is allowed as long as the view of the sign is not obstructed. Time delays caused by unforeseen circumstances, such as equipment breakdown, rain, subgrade failures, etc., will not accrue towards the 5 day period. Use of R9-8 through R9-11a series, W1-6 through W1-8 series, M4-10, and E5-1 is allowed for longer than 5 days.
Restrict signs mounted on portable sign supports shown in the LOW-MOUNTING HEIGHT and HIGH-MOUNTING HEIGHT details to a maximum surface area of 16 square feet.

MINIMUM BALLAST
(For each side of sign support base)

Sign Panel Mounting Height (ft)	Number of 25 lb sandbags for 4' x 4' sign panel
1'	6
5'	8
7'	10

Note: The number of sandbags are based on a wind speed of 55 MPH. Place sandbags at or near the ends of sklds.

NORTH DAKOTA DEPARTMENT OF TRANSPORTATION	
10-4-13	
REVISIONS	
DATE	CHANGE
11-14-13	Revised Note 6
9-27-17	Updated to active voice
11-01-19	Revised 60"x24" sign detail
8-01-24	Electronic Stamp/Signature



08/01/24

ROAD CLOSURE AND LANE CLOSURE ON A TWO WAY ROAD LAYOUTS

Notes:

- Variables
 S = Numerical value of speed limit or 85th percentile.
 W = The width of taper in feet
 L = Minimum length of taper in feet. $S \times W$ for freeways, expressways, and roads with speeds of 45 mph or greater, or $W \times S^2/60$ for urban, residential, and streets with speeds of 40 mph or less.
- Place barricades on moveable assemblies and signs on portable assemblies when located on the roadway.
- Place delineator drums for tapering traffic at 3 equal spaces and for tangents space them at 2 times dimension "S".
- Re-establish speed limit. Determine exact speed limit in the field, dependent on location and conditions.
- Determine the reduced speed limit based on the in place speed limit before construction. Where speed reductions exceed 30 mph, install a second speed limit sign with the desired speed reduction (not to exceed 30 mph.) Place second speed limit sign at $\frac{1}{2}B$.
- Install flags on warning signs in urban areas when signs are not portable. Mount 24 inch square flags perpendicular to the edges of the sign, and at such a distance above the edge that the flag does not touch the sign when limp.
- Cover existing speed limit signs within a reduced speed zone.
- Where necessary, safe speed to be determined by the Engineer.
- As an option, use portable sign supports in lieu of post mounted signs in accordance with NDDOT Standard Drawing D-704-14.
- Signs G20-55-96 or R2-1aP-24 are not required when pilot car operation is used, if this layout is part of other traffic control that contains this sign, or if work is less than 15 days. When highway-rail grade crossings exist either within or in the vicinity of the roadway work activities:
 - Extra care shall be taken to minimize the probability of conditions being created, either by lane restrictions, flagging or other operations, where vehicles might be stopped within the highway-rail grade crossing (considered as being 15 feet on either side of the closest and farthest rail.)
 - Place "Do Not Stop on Tracks" sign (R8-8-24) near cross buck in each direction while lane closure is near tracks.
 - Extend buffer space between work zone and lane closure transition upstream of the highway-rail grade crossing to prevent flagging queue from extending across highway-rail grade crossing.
 - If queuing extends across highway-rail crossing, provide flagger at crossing to prevent vehicles from stopping within the crossing (even when automatic warning devices are in place.)
- Recommend using 40 mph speed limit in vicinity of workers, unless location and conditions dictate otherwise.

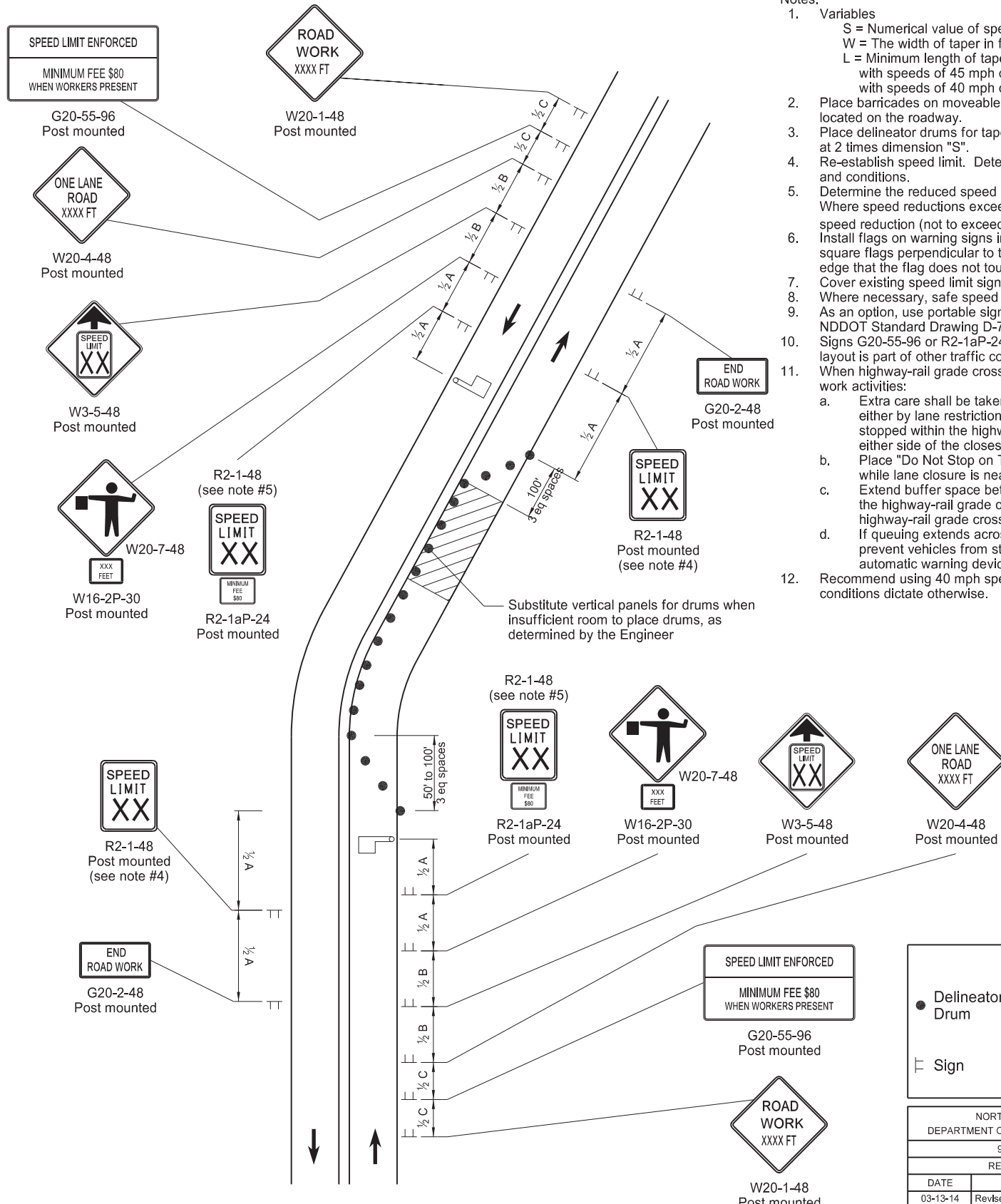
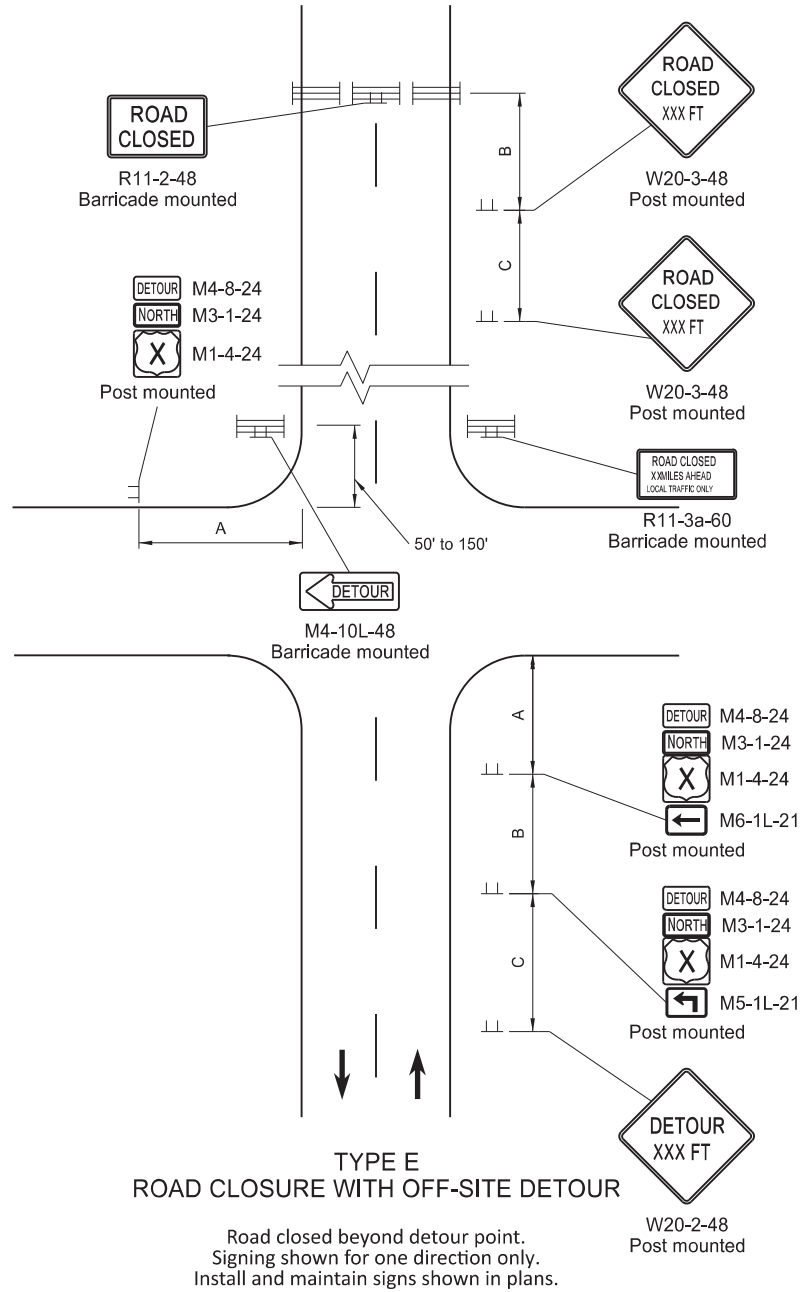

ADVANCE WARNING SIGN SPACING			
Road Type	Distance Between Signs Min. (ft)		
	A	B	C
Urban - Low Speed (30 mph or less)	150	150	150
Urban - Low Speed (over 30 to 40mph)	280	280	280
Urban - High Speed (over 40 mph to 50 mph)	360	360	360
Rural - High Speed (over 50 mph to 65 mph)	720	720	720
Urban Expressway and Freeway (55 mph to 60 mph)	850	1350	2200
Rural Expressway and Freeway (70 mph to 75 mph)	1000	1500	2640
Interstate/4-Lane Divided (Maintenance and Surveying)	750	1000	1500

KEY

- Delineator Drum
- Sign
- Type III Barricade
- Work/Hazard Area
- Flagger

NORTH DAKOTA DEPARTMENT OF TRANSPORTATION	
9-27-13	
REVISIONS	
DATE	CHANGE
03-13-14	Revised Sign Cell "ROAD WORK XXX FT"
08-17-17	Update notes & sign numbers
11-01-19	Revised signs, sign #s, & notes
12-08-21	Switched order of Road Work XXX and Spd Limit Enforced & added Dollars At Work
11-29-22	Removed Dollars At Work



DETOUR AND ROADWAY DIVERSION SIGN LAYOUTS

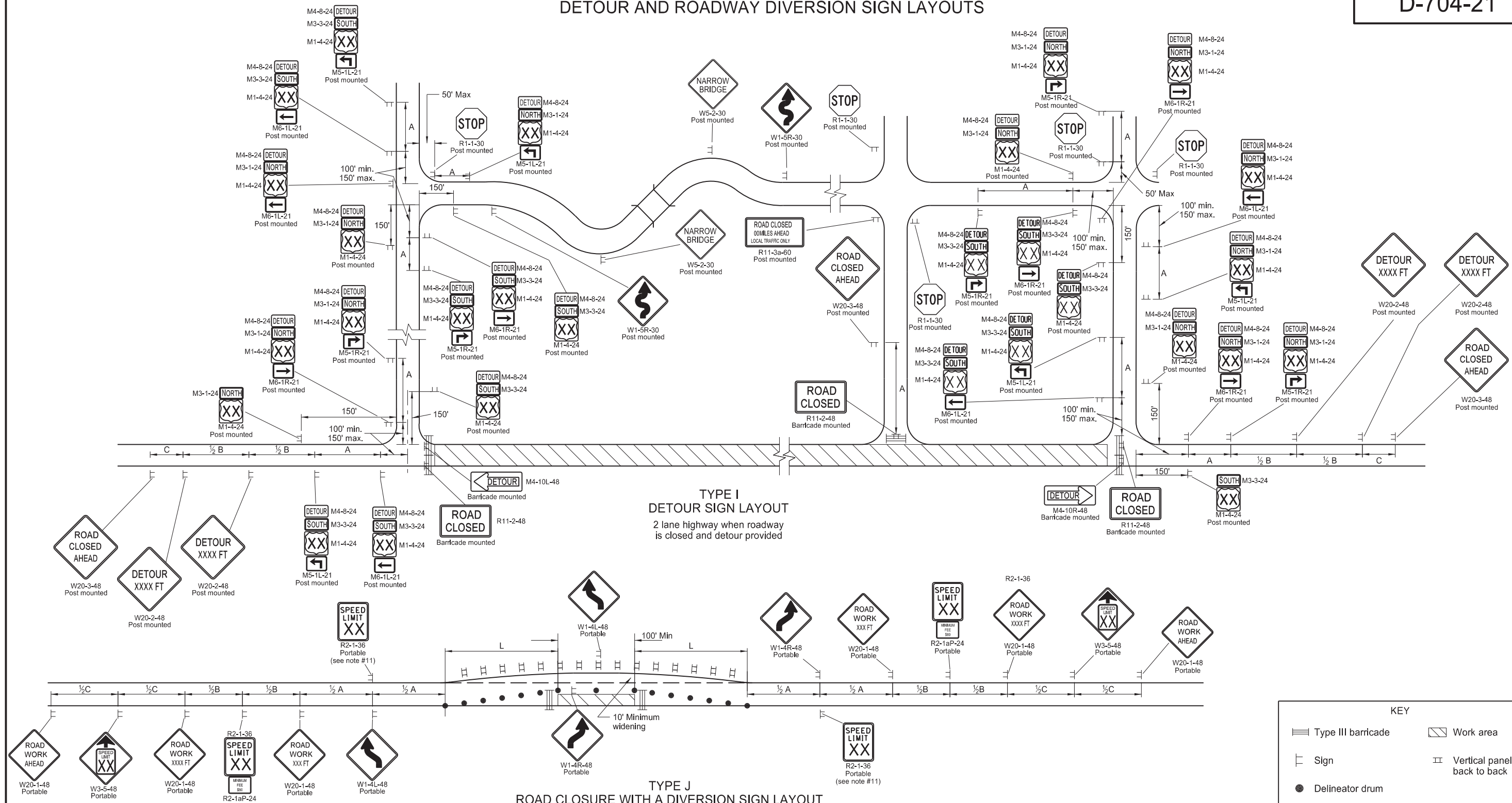

TYPE I
DETOUR SIGN LAYOUT
2 lane highway when roadway is closed and detour provided

TYPE J
ROAD CLOSURE WITH A DIVERSION SIGN LAYOUT
2 lane highway with widened section, traffic maintained in both directions.

Use layout when work is less than 5 days or is within a project.

- Notes:
- Variables
S= Numerical value of speed limit or 85th percentile. W= The width of taper.
L= Minimum length of taper, or $S \times W$ for freeways, expressways, and all other roads with speeds of 45 mph or greater, or $W \times S^2 / 60$ for urban, residential, and other streets with speeds of 40 mph or less.
 - Place barricades on moveable assemblies and signs on portable assemblies when on roadway.
 - Space delineator drums and vertical panels at dimension "S" for tapering traffic. Space delineator drums, tubular markers and vertical panels at 2 times "S" for tangents.
 - Determine the reduced speed limit based on the in place speed limit before construction. Where speed limits exceed 30 MPH, install a second speed limit sign with the desired speed reduction (not to exceed 30 mph.) Place the second speed limit sign at $\frac{1}{2} B$.
 - Install flags on warning signs in urban areas when signs are not portable. Mount 24 inches square flags perpendicular to the edges of the sign, and at such a distance above the edge that the flag does not touch the sign when limp.
 - Cover existing speed limit signs within a reduced speed limit zone.
 - Covered (when approved by engineer) or obliterated pavement marking measured as Obliteration of Pavement Marking.
 - As an option, use portable sign supports in lieu of post mounted signs in accordance with NDDOT Standard Drawing D-704-14.
 - If the tangent between tapers is less than 600', as an option, use sign W24-1-48 in place of double reverse curve signs.
 - Recommend using 40 mph speed limit in vicinity of workers, unless location and conditions dictate otherwise.
 - Re-establish speed limit. Determine exact speed limit in the field, dependent on location and conditions.

Road Type	Distance Between Signs Min. (ft)		
	A	B	C
Urban - Low Speed (30 mph or less)	150	150	150
Urban - Low Speed (over 30 to 40 mph)	280	280	280
Urban - High Speed (over 40 mph to 50 mph)	360	360	360
Rural - High Speed (over 50 mph to 65 mph)	720	720	720
Urban Expressway and Freeway (55 mph to 60 mph)	850	1350	2200
Rural Expressway and Freeway (70 mph to 75 mph)	1000	1500	2640
Interstate/4-Lane Divided (Maintenance and Surveying)	750	1000	1500

KEY

- Type III barricade
- Work area
- Sign
- Vertical panels back to back
- Delineator drum

NORTH DAKOTA DEPARTMENT OF TRANSPORTATION	
9-27-13	
REVISIONS	
DATE	CHANGE
08-17-17	Updated notes & added spd limit
11-01-19	Revised sign #s and note 8
12-08-21	Added Dollars At Work sign
11-29-22	Removed Dollars At Work

KIRK J. HOFF
REGISTERED
PROFESSIONAL
PE-4683
ENGINEER
NORTH DAKOTA
11/29/22

PORTABLE SIGN SUPPORT ASSEMBLY

D-704-50

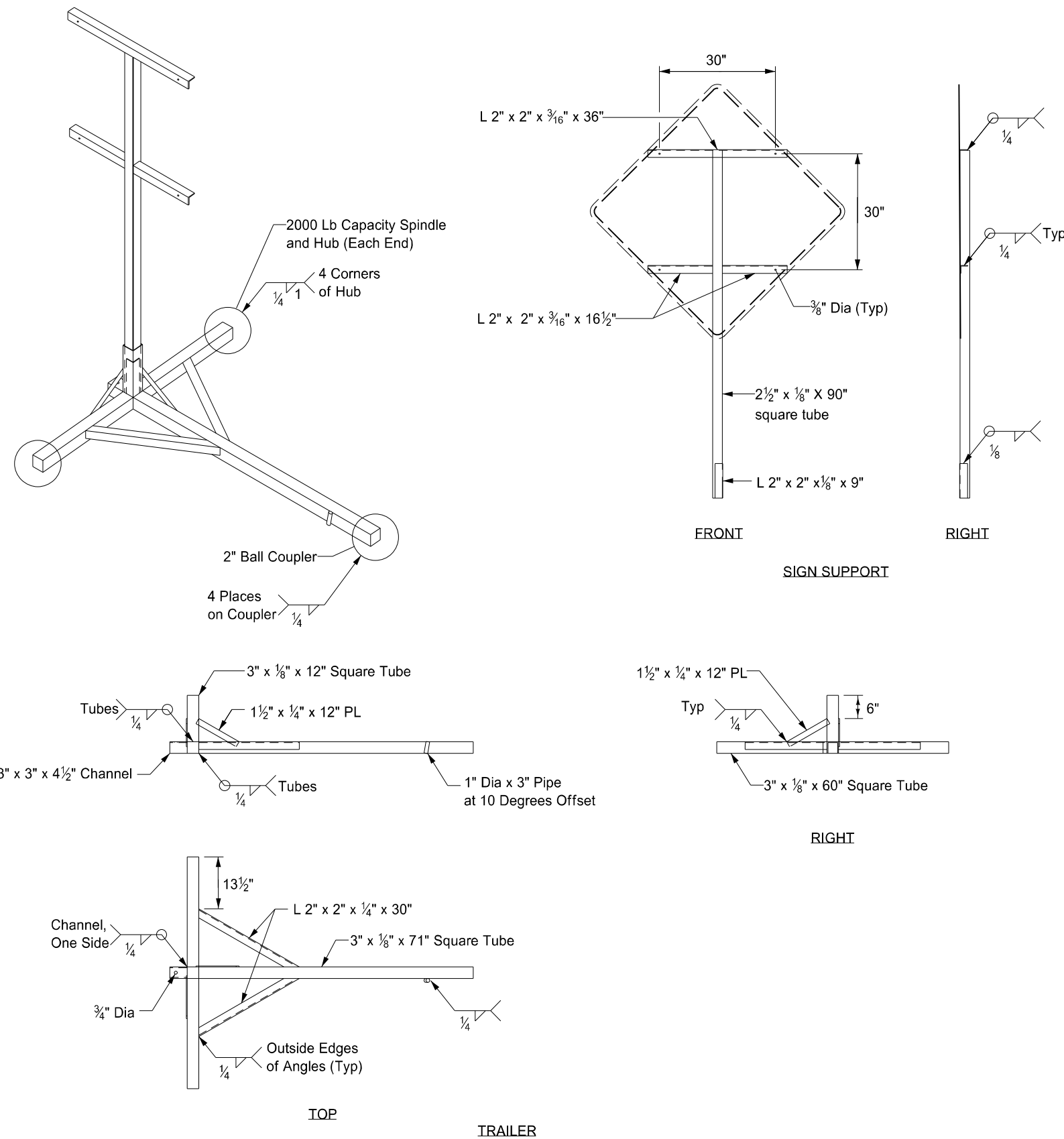

Notes:

- ①. Maximum 250 pound weight of assembly.
- ②. Use a 14" wheel and tire.
- ③. Use no automotive and equipment axle assemblies for trailer-mounted sign supports.
- ④. Other NCHRP 350 or MASH crash tested assemblies are acceptable.

NORTH DAKOTA DEPARTMENT OF TRANSPORTATION	
11-23-10	
REVISIONS	
DATE	CHANGE
12/02/2020	Updated Note to active voice.

KIRK J. HOFF
 REGISTERED
 PROFESSIONAL
 PE-4683
 ENGINEER
 NORTH DAKOTA
 12 02 2020